

MILLWORK INTERNATIONAL INC. CROWNS
MI 200 SECTION

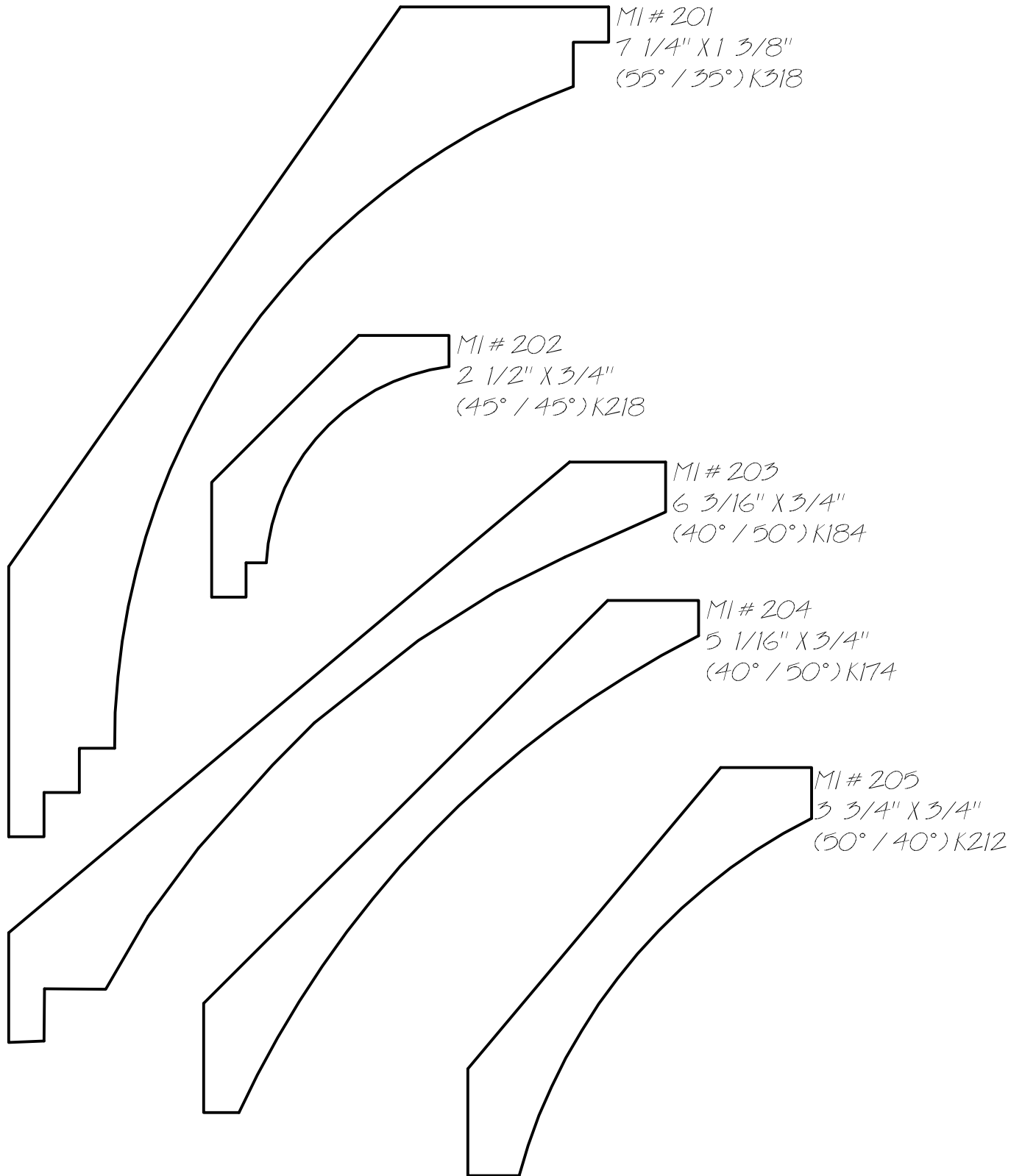

MILLWORK INTERNATIONAL INC. CROWNS

MI 200 SECTION

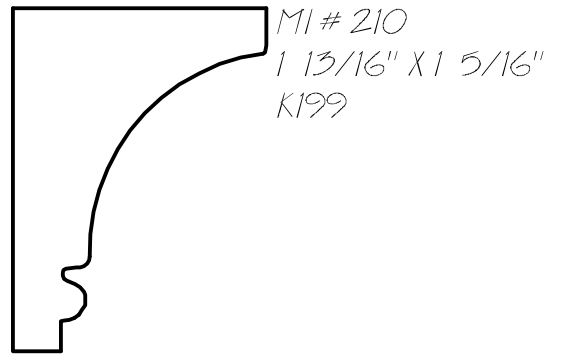
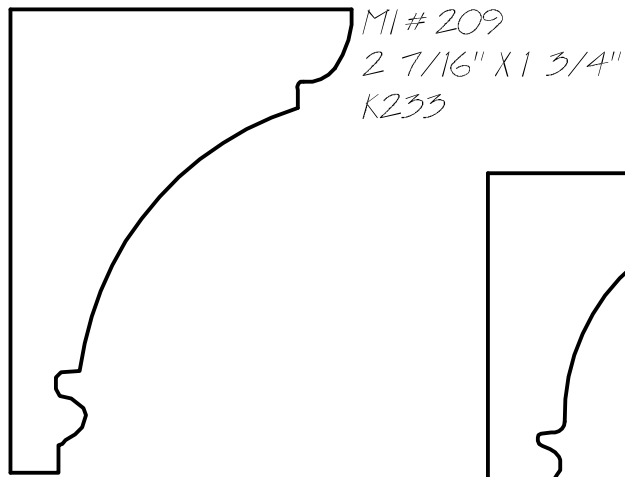
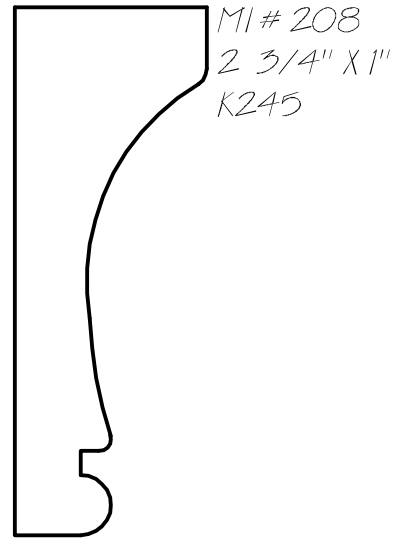
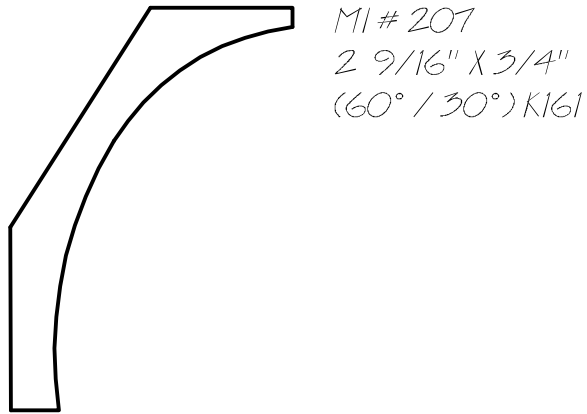
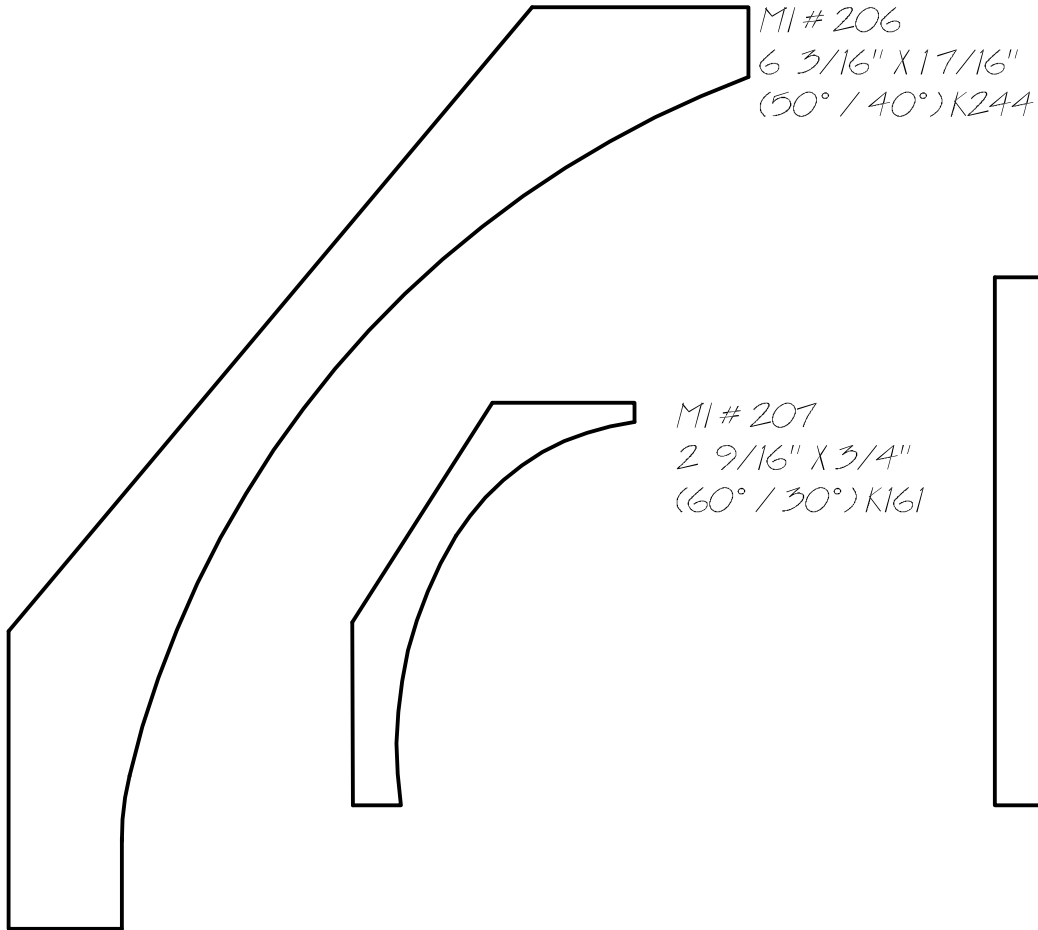

MILLWORK INTERNATIONAL INC, CROWNS
MI 200 SECTION

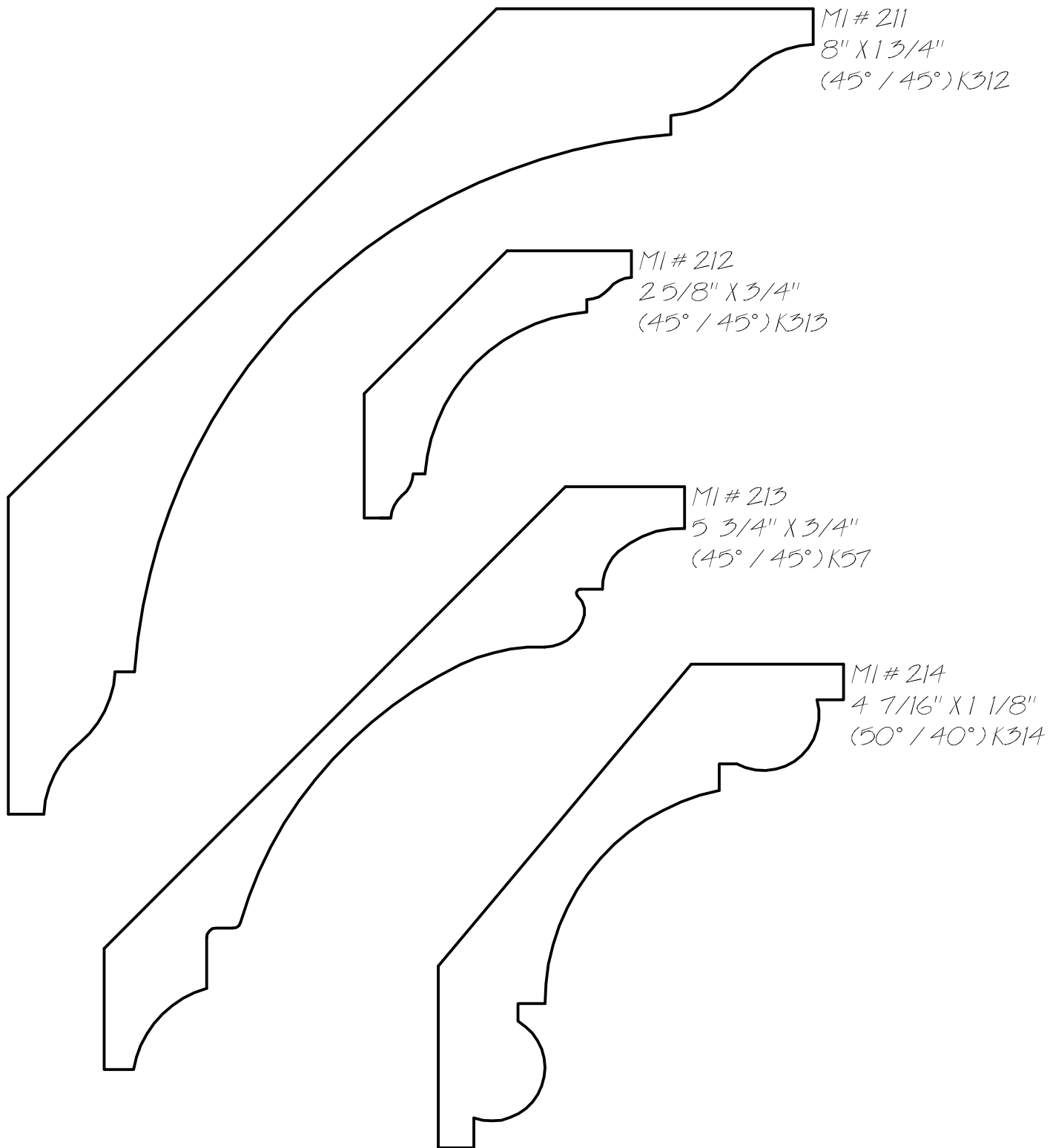

MILLWORK INTERNATIONAL INC. CROWNS
MI 200 SECTION

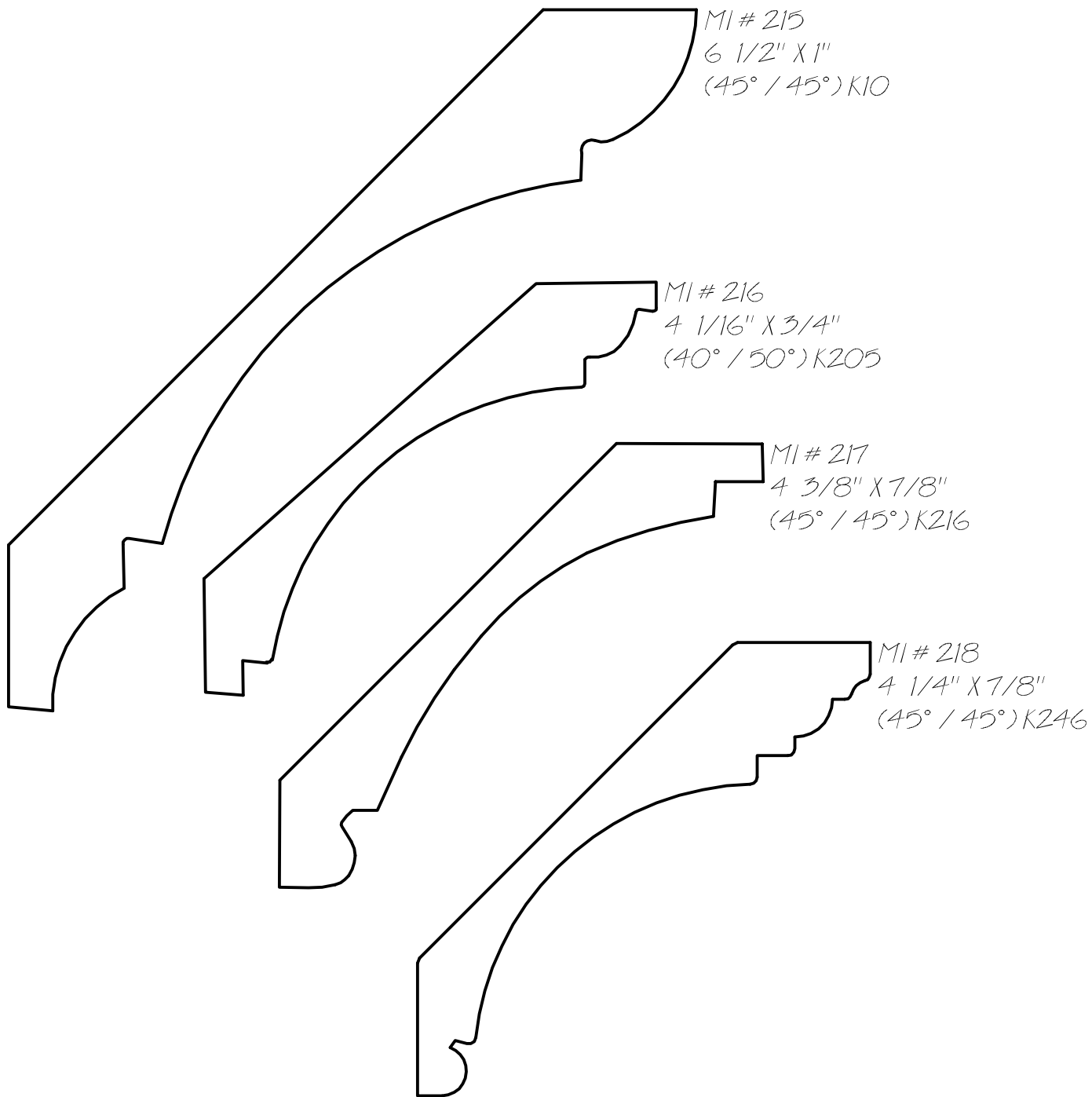

MILLWORK INTERNATIONAL INC. CROWNS

MI 200 SECTION

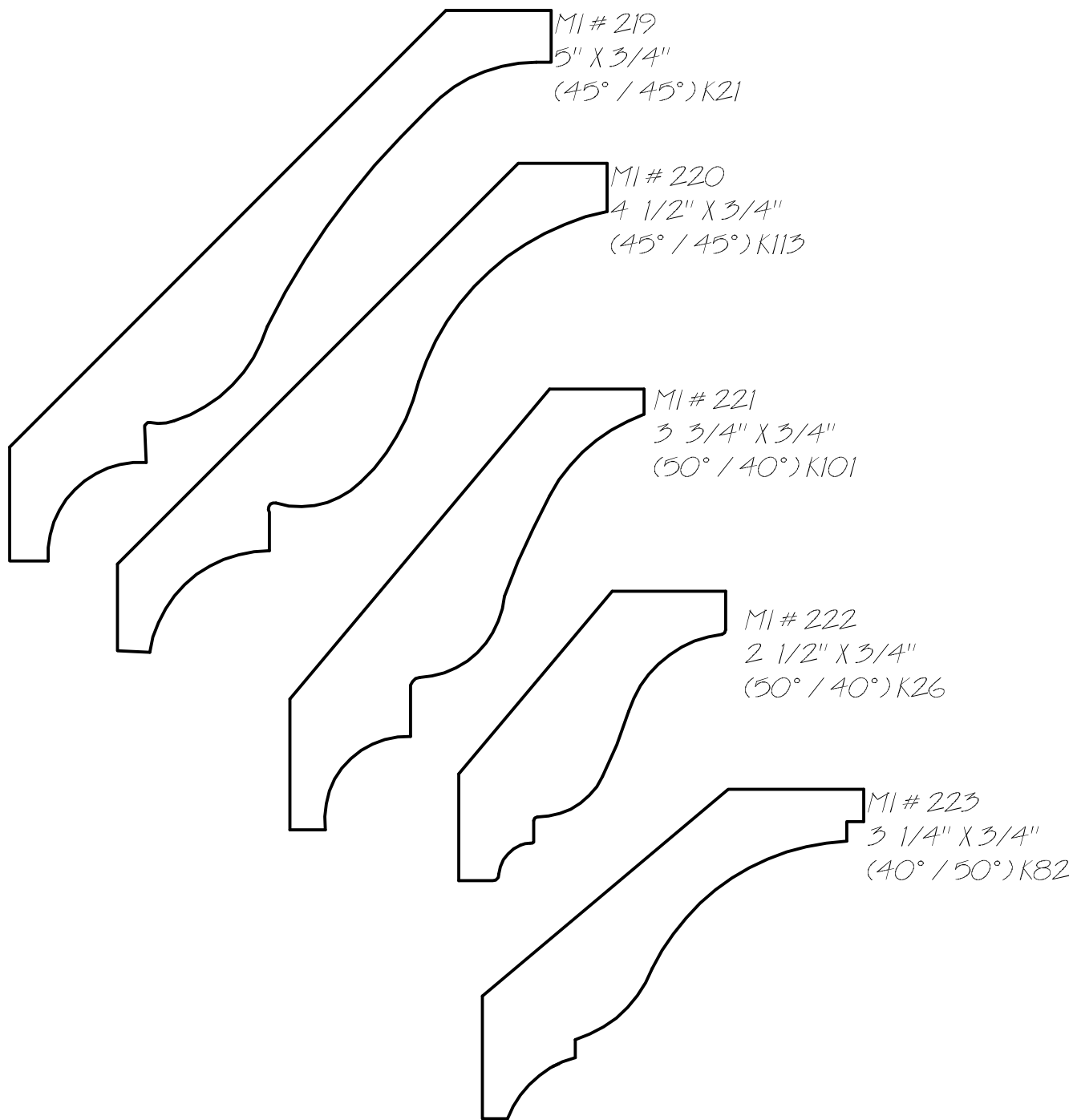

MILLWORK INTERNATIONAL INC, CROWNS
MI 200 SECTION

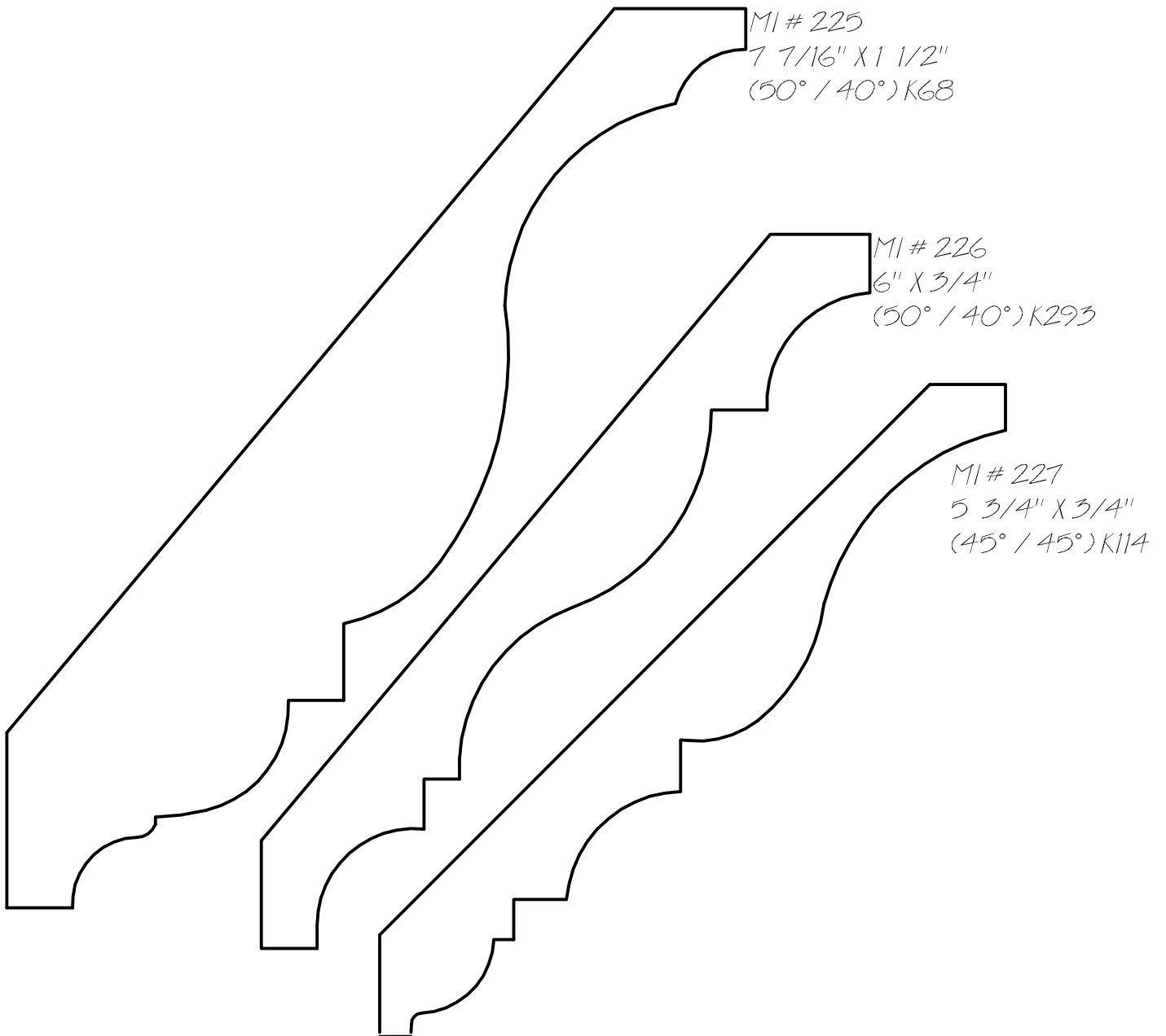

MILLWORK INTERNATIONAL INC. CROWNS

MI 200 SECTION

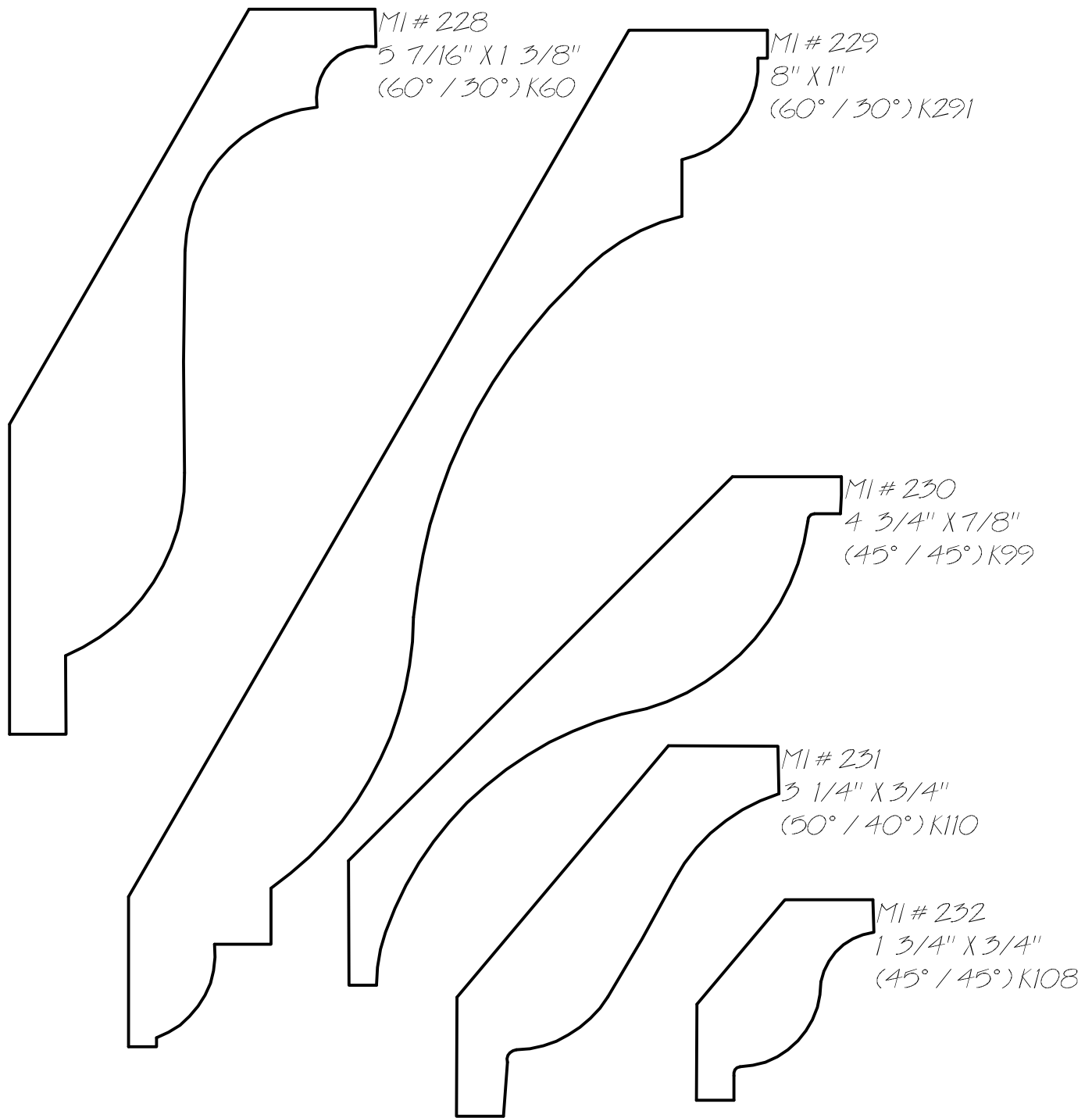

MILLWORK INTERNATIONAL INC. CROWNS
MI 200 SECTION

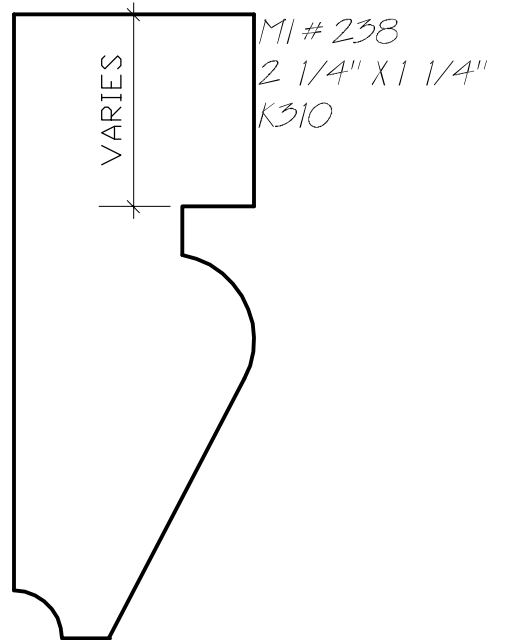
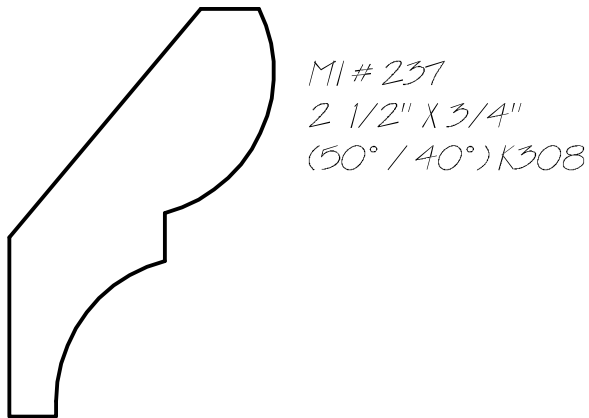
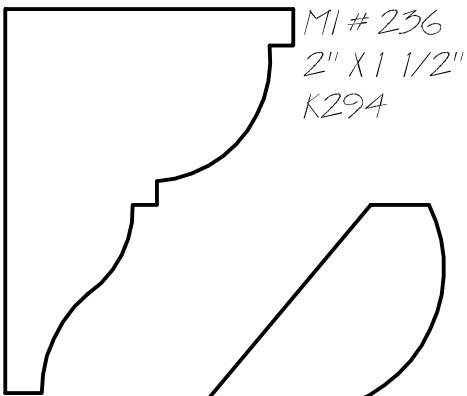
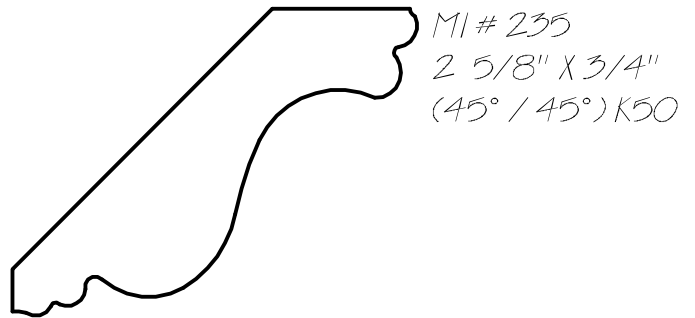
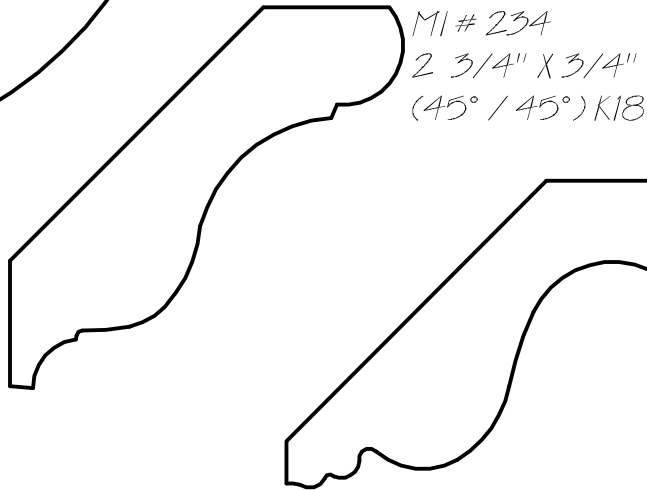
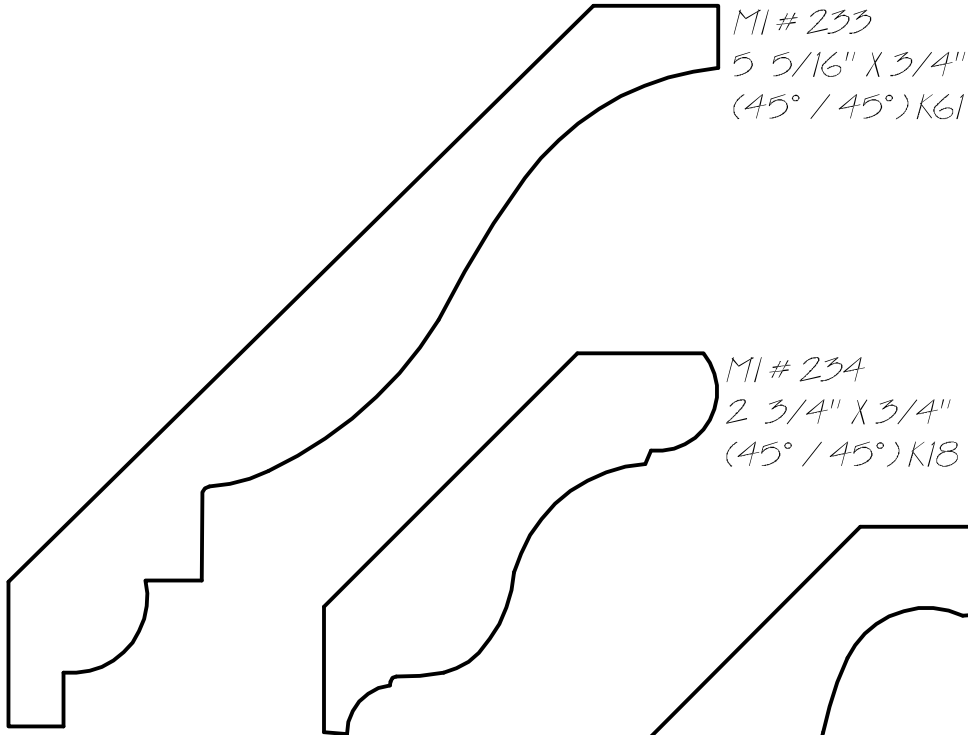

MILLWORK INTERNATIONAL INC. CROWNS

MI 200 SECTION

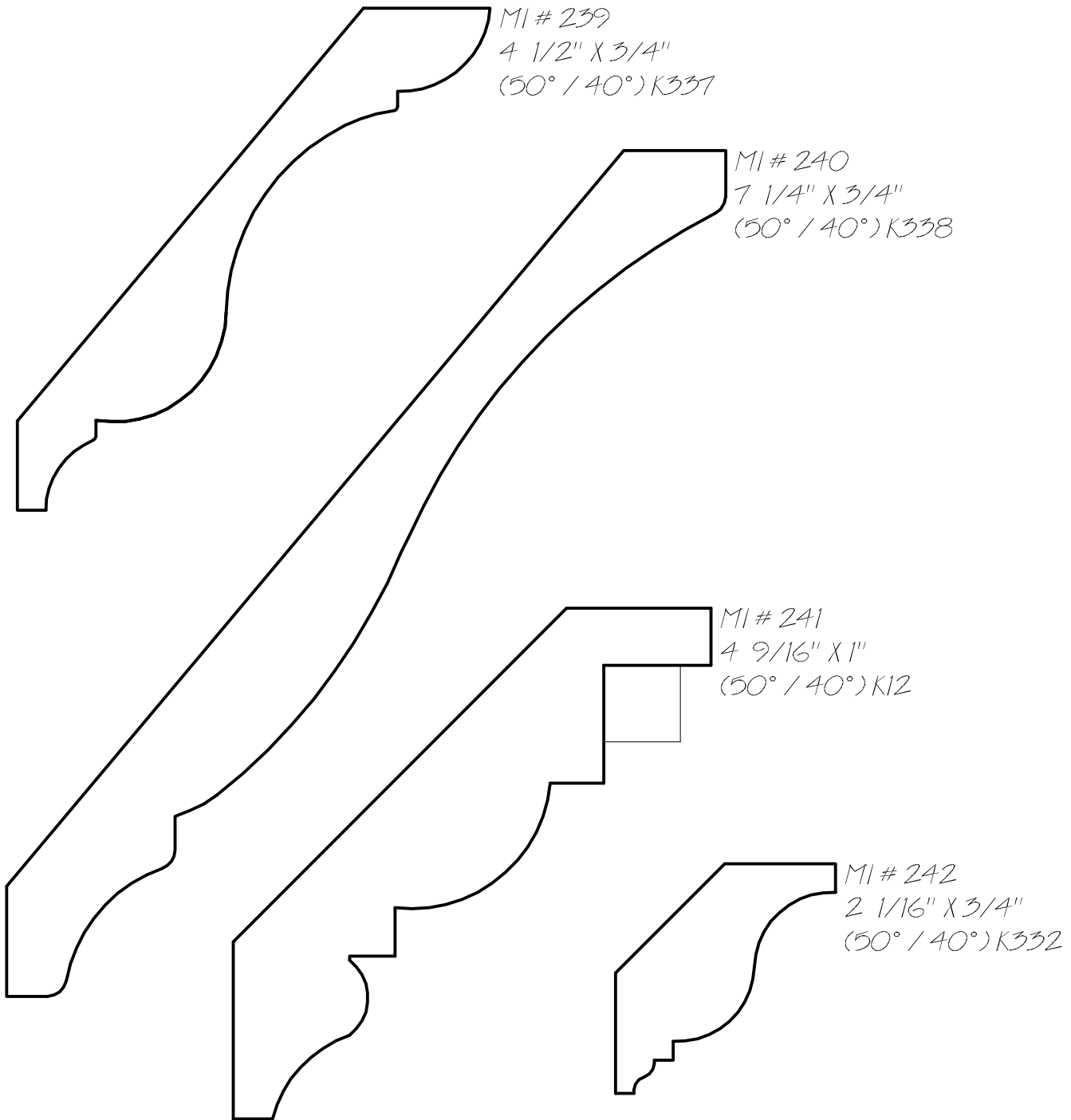

MILLWORK INTERNATIONAL INC. CROWNS
MI 200 SECTION

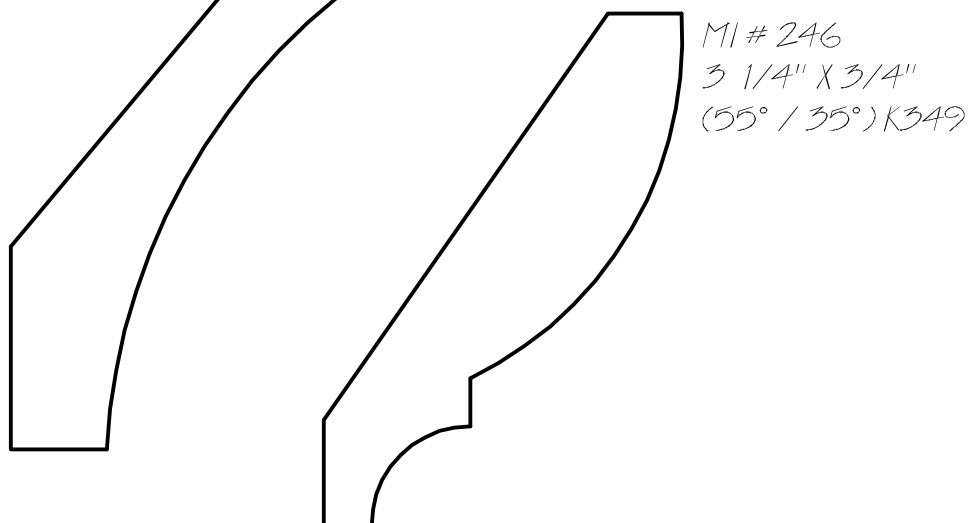
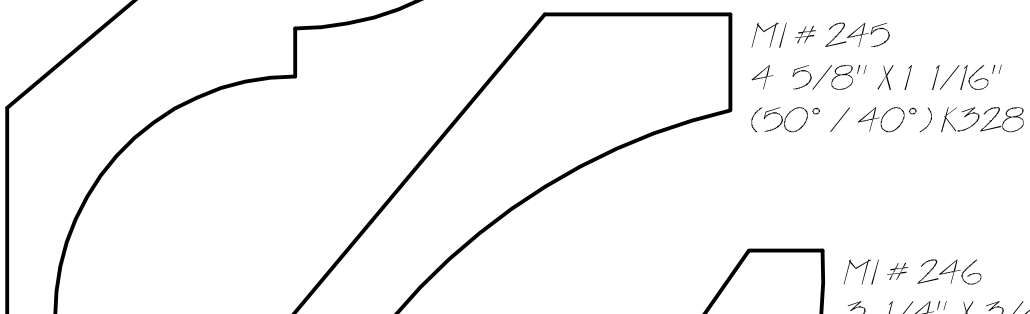
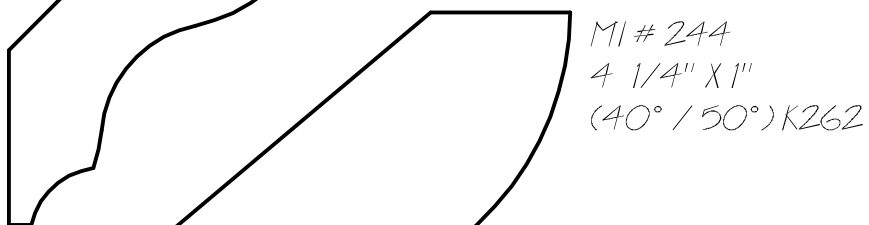

MILLWORK INTERNATIONAL INC. CROWNS
MI 200 SECTION

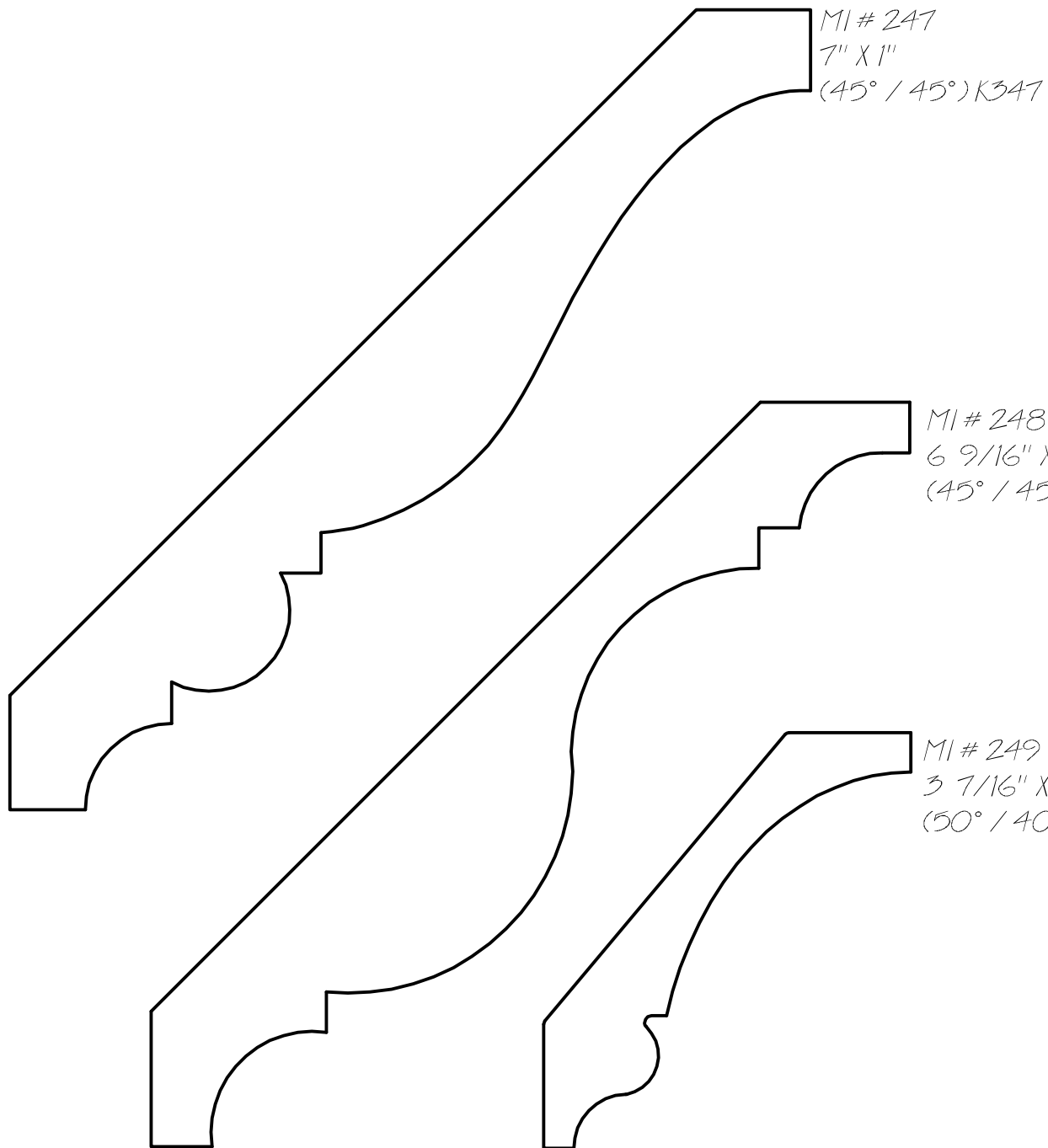

MILLWORK INTERNATIONAL INC. CROWNS

MI 200 SECTION

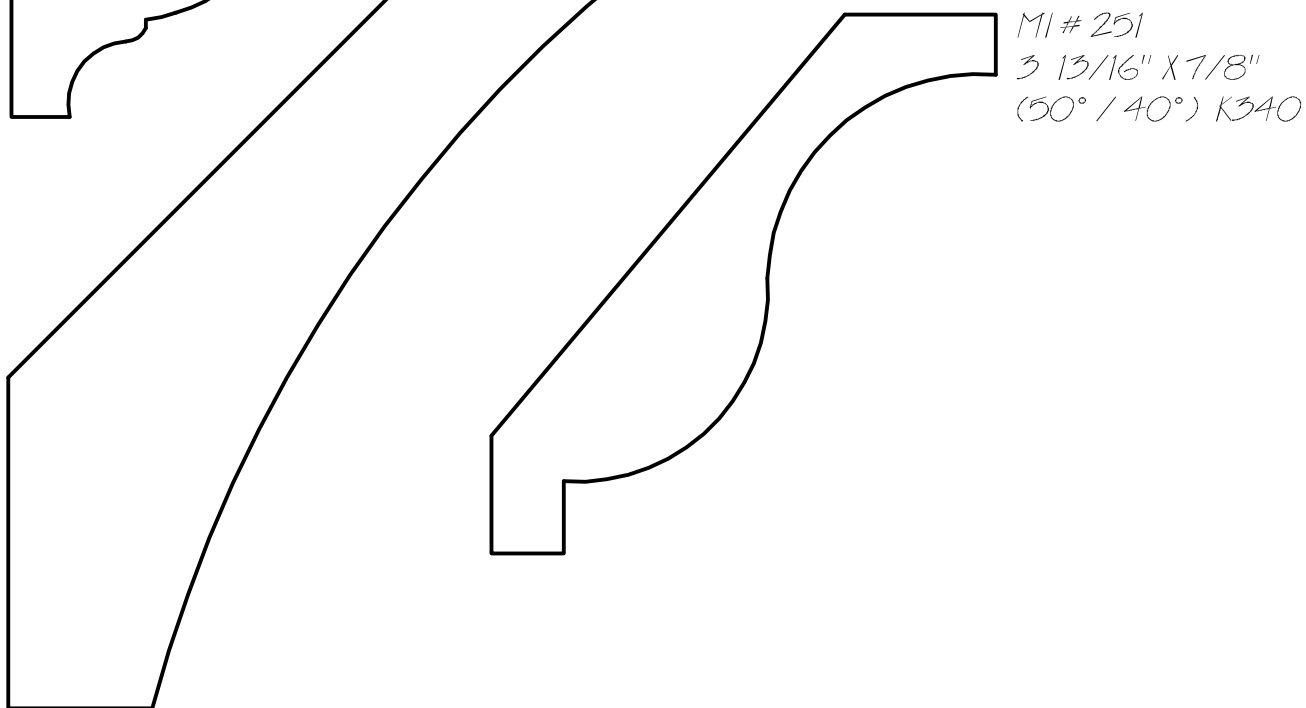
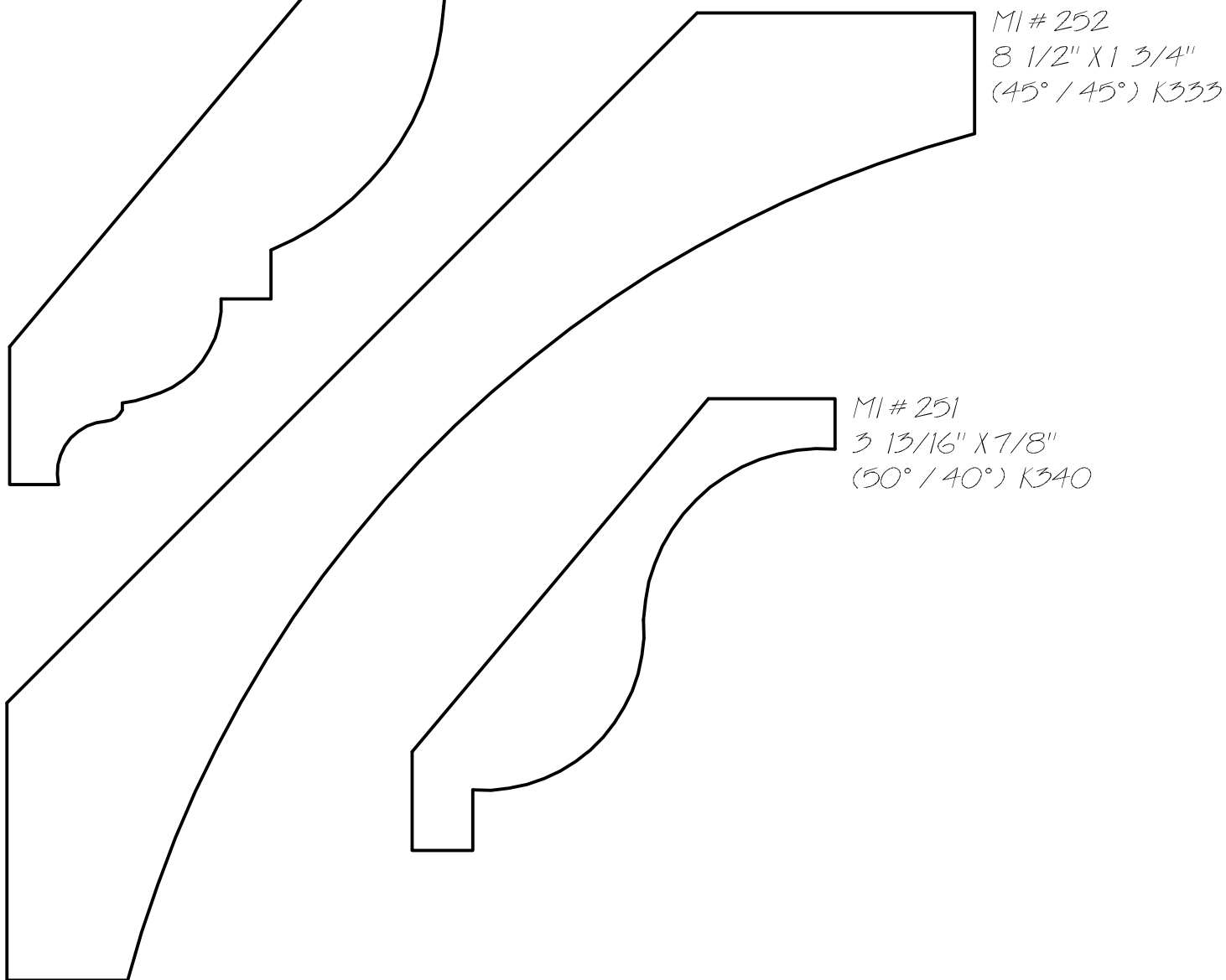
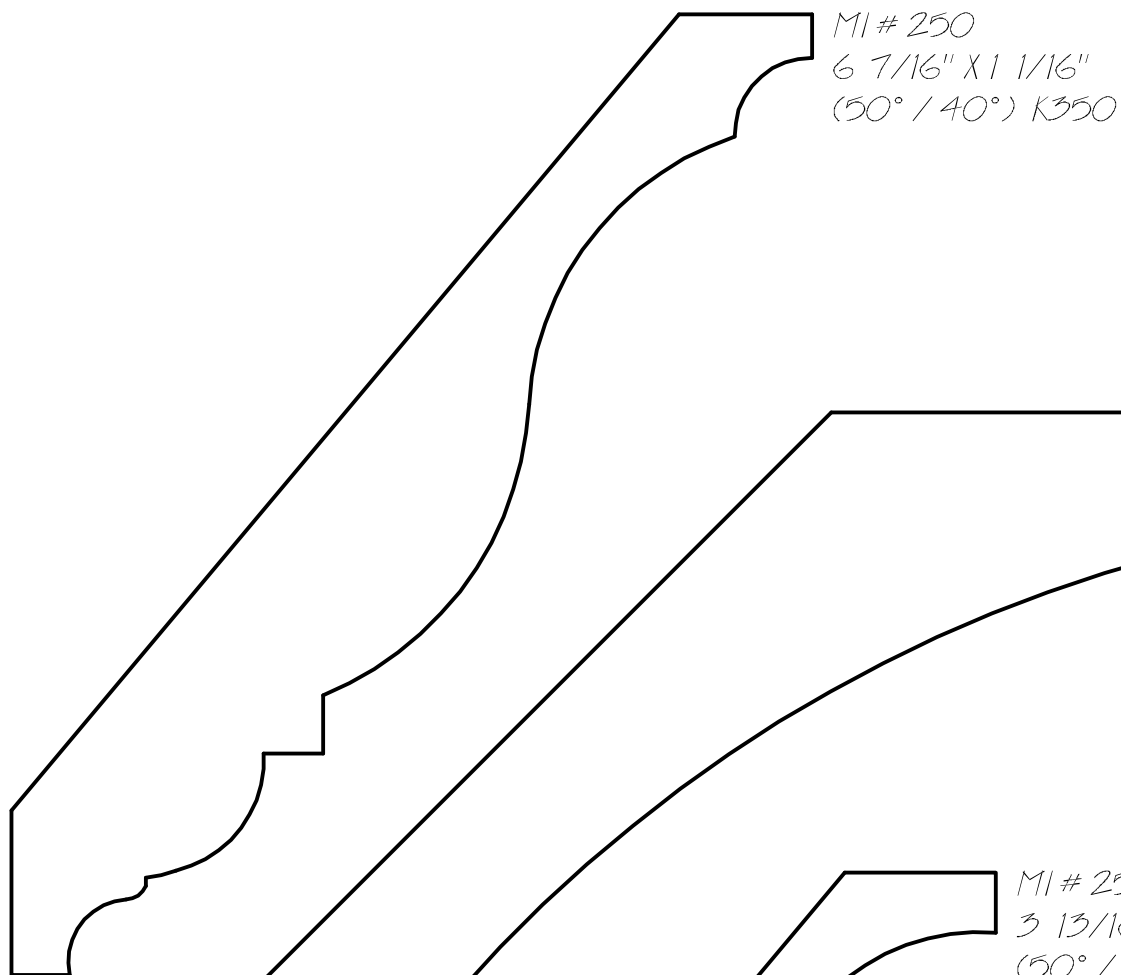

MILLWORK INTERNATIONAL INC. CROWNS

MI 200 SECTION

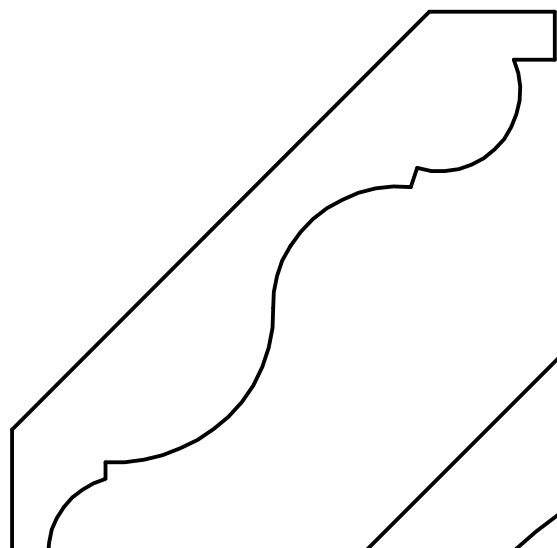

MI # 253
4" X 3/4"
(45° / 45°) K304

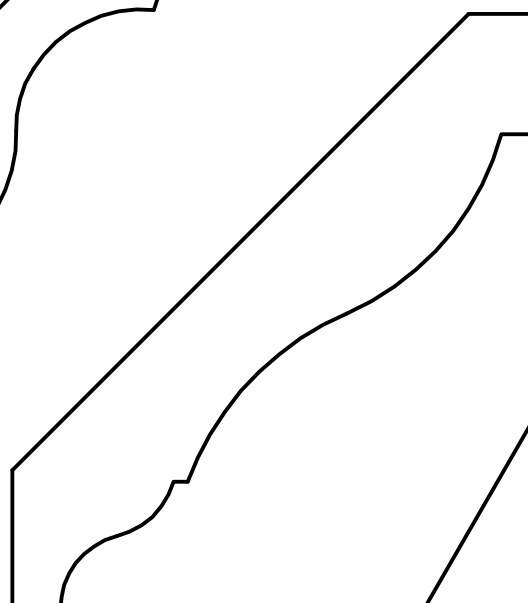

MI # 254
4 1/8" X 3/4"
(45° / 45°) K302



MI # 255
5 7/8" X 3/4"
(60° / 30°) K301



MI # 256
1 5/16" X 15/16"
K358



MI # 257
2 1/8" X 1 5/8"
K359

MILLWORK INTERNATIONAL INC. CROWNS
MI 200 SECTION



MI # 257-A
1 1/2" x 9 1/4"
K369-A

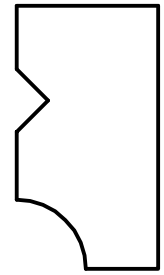

MI # 257-C
3/4" x 1 3/8"
K369-C

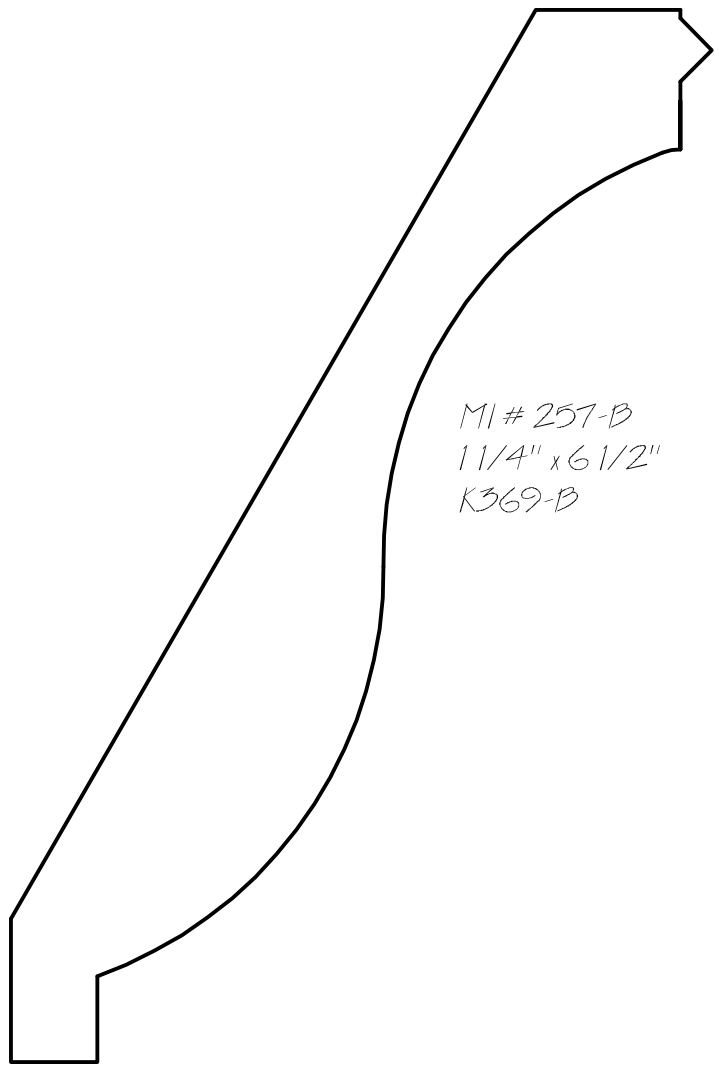

MI # 257-B
1 1/4" x 6 1/2"
K369-B

MILLWORK INTERNATIONAL INC. CROWNS

MI 200 SECTION

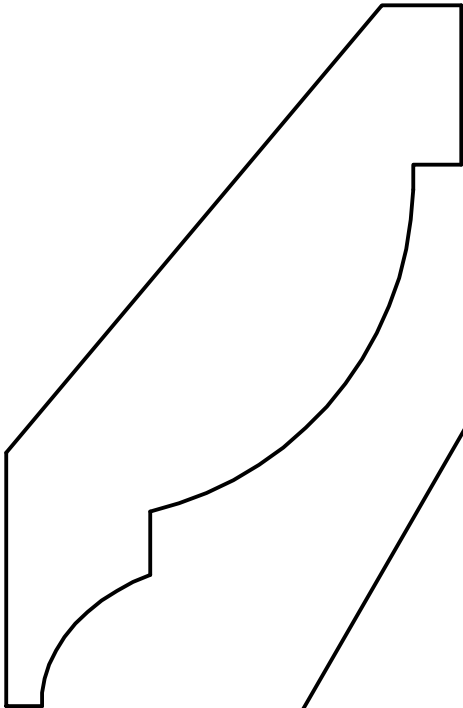

MI # 258
4 3/8" X 1 1/8"
(50° / 40°) K378



MI # 259
3 7/8" X 1"
(60° / 30°) K379

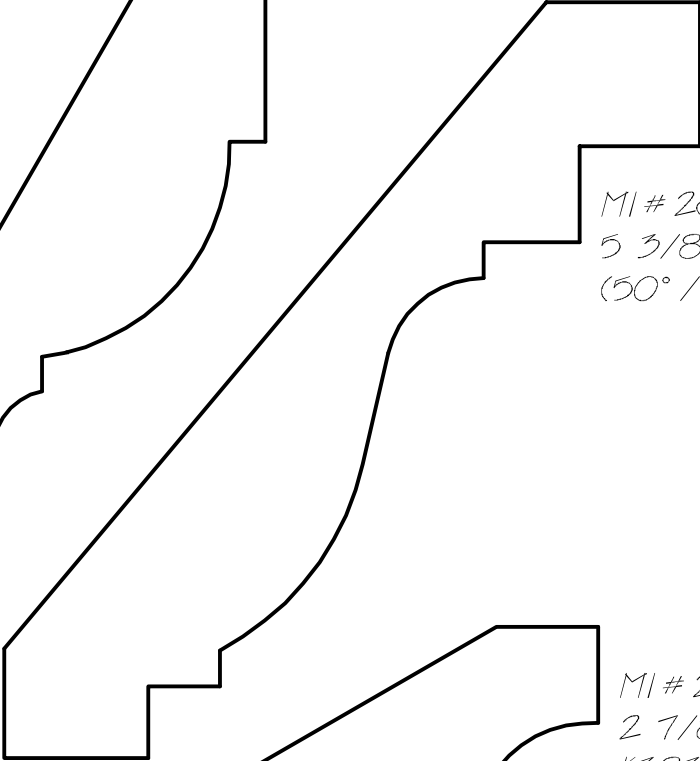

MI # 260
5 3/8" X 1"
(50° / 40°) K381

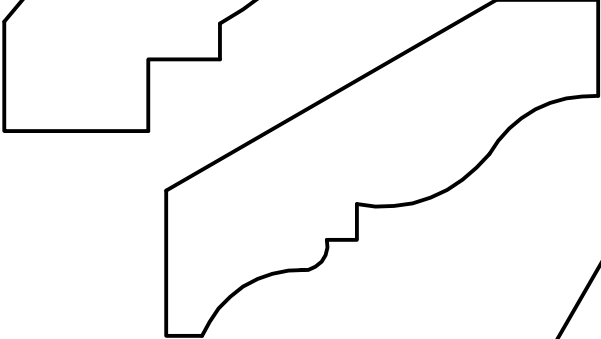

MI # 262
2 7/8" X 3/4"
K383

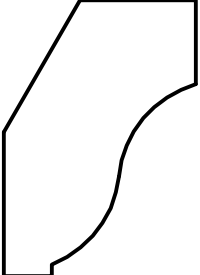

MI # 263
1 3/4" X 13/16"
K384

MILLWORK INTERNATIONAL INC. CROWNS

MI 200 SECTION

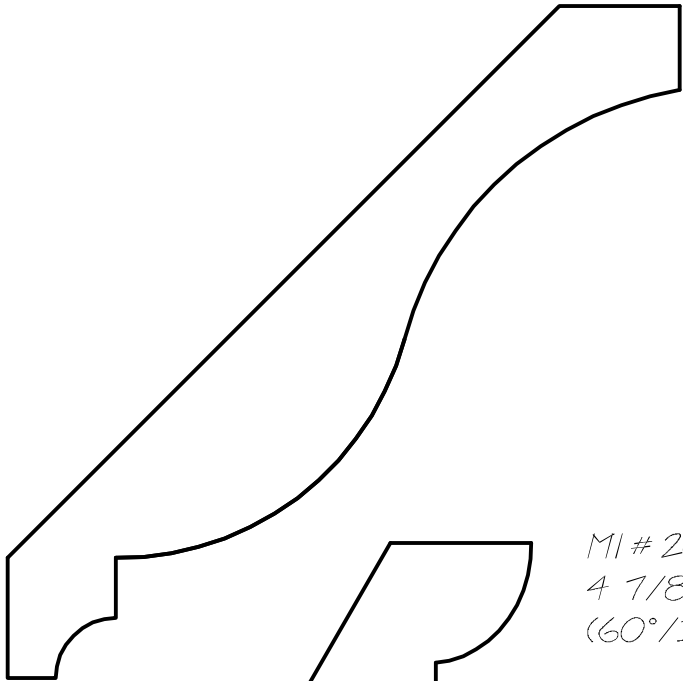

MI # 264
5" X 3/4"
(45° / 45°) K386

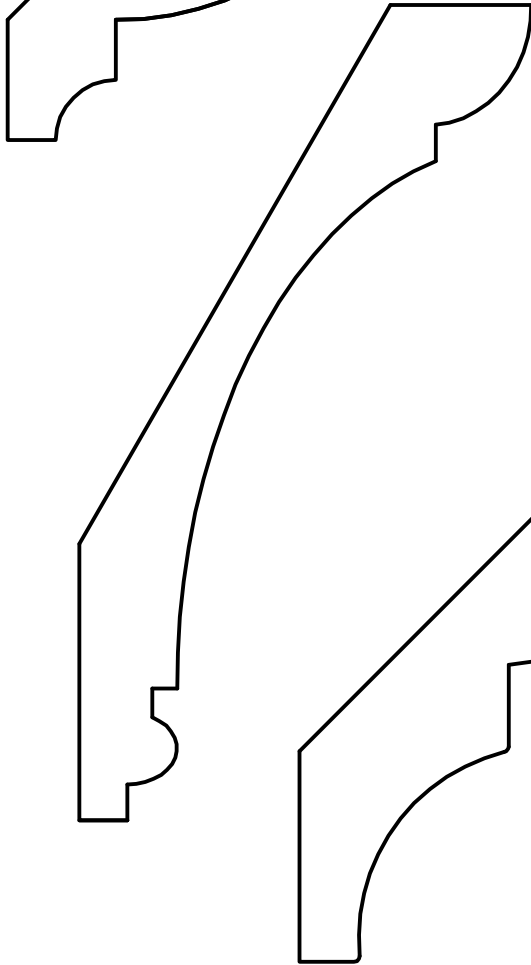

MI # 265
4 7/8" X 1"
(60° / 30°) K394

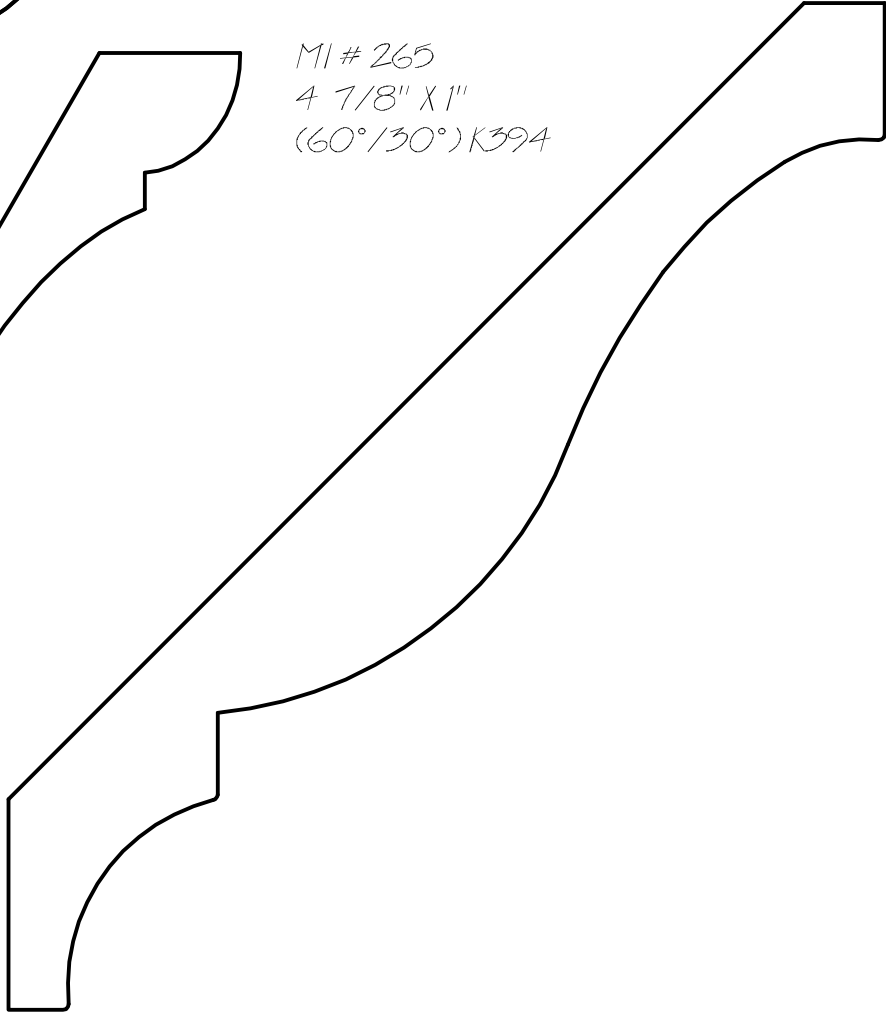

MI # 266
7" X 1"
(45° / 45°) K395

MILLWORK INTERNATIONAL INC. CROWNS
MI 200 SECTION

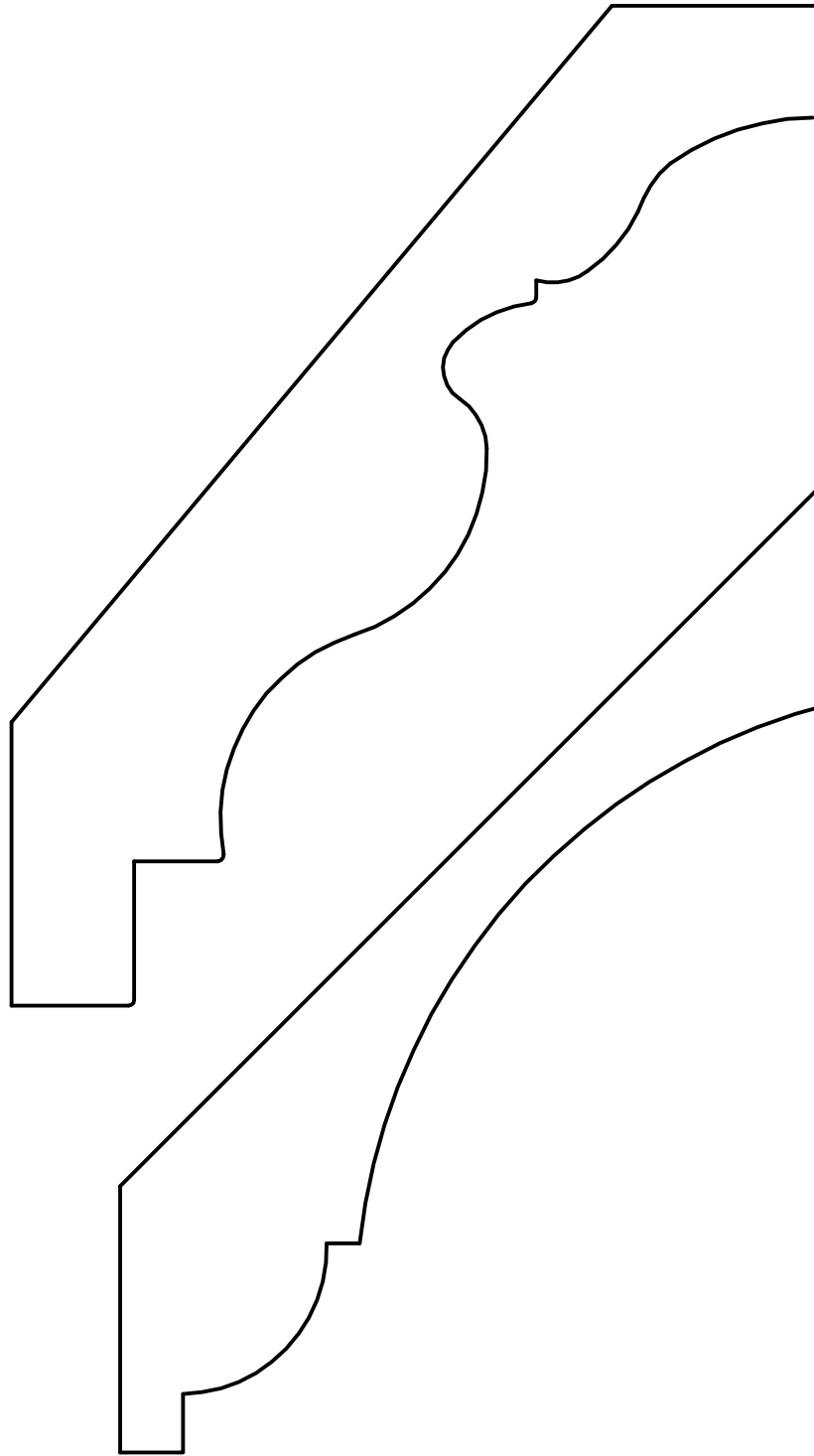

MI # 267
6 3/4" X 1 7/16"
(50°/40°) K396

MI # 268
7 7/16" X 1 1/4"
(45°/45°) K397

MILLWORK INTERNATIONAL INC. CROWNS
MI 200 SECTION

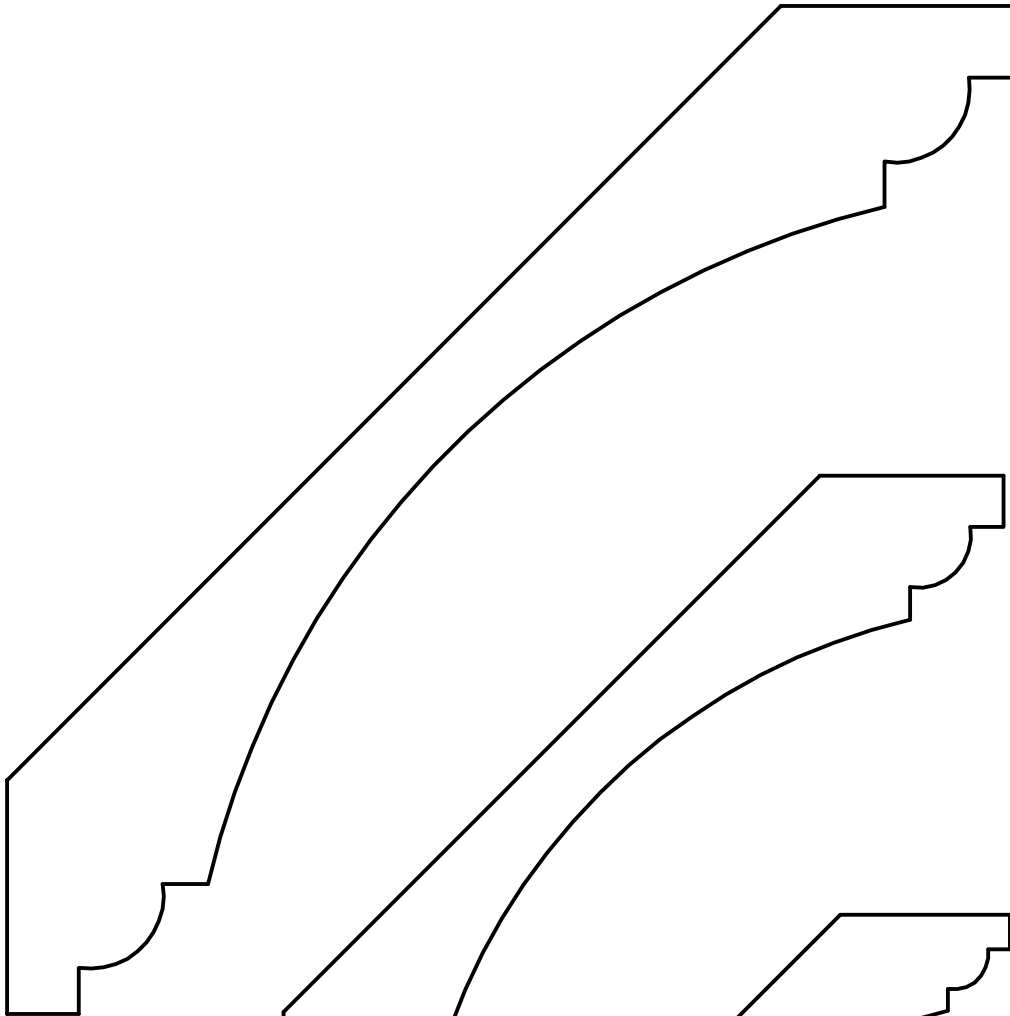

MI # 269
7 7/16" X 1 1/8"
(45°/45°) K398

MI # 270
5 5/16" X 7/8"
(45°/45°) K399

MI # 271
3 9/16" X 3/4"
(45°/45°) K400

MI # 272
1 3/4" X 1 1/2"
K401

MILLWORK INTERNATIONAL INC. CROWNS
MI 200 SECTION

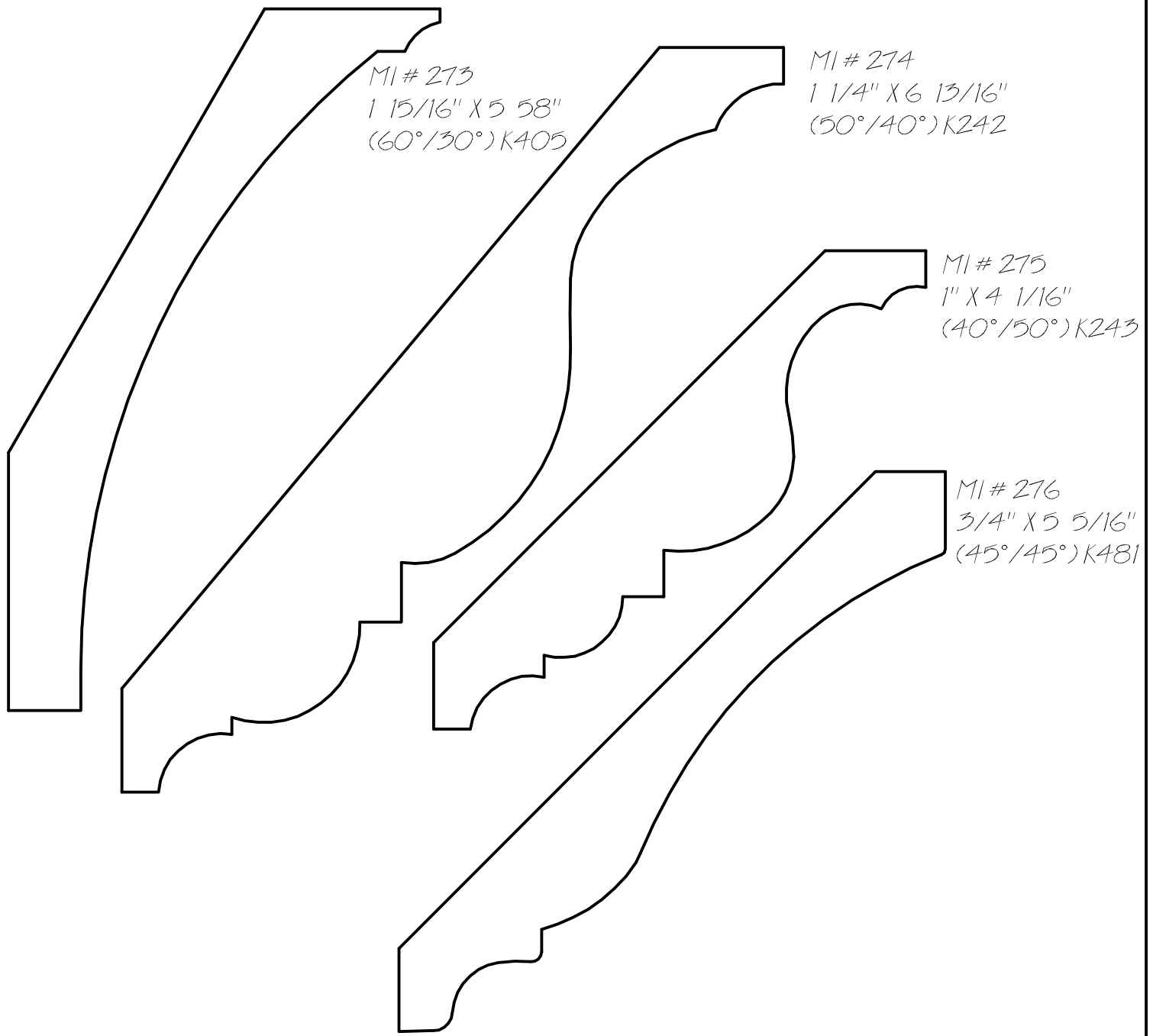

MI # 273
1 15/16" X 5 5/8"
(60°/30°) K405

MI # 274
1 1/4" X 6 13/16"
(50°/40°) K242

MI # 275
1" X 4 1/16"
(40°/50°) K243

MI # 276
3/4" X 5 5/16"
(45°/45°) K481

MILLWORK INTERNATIONAL INC, CROWNS
MI 200 SECTION

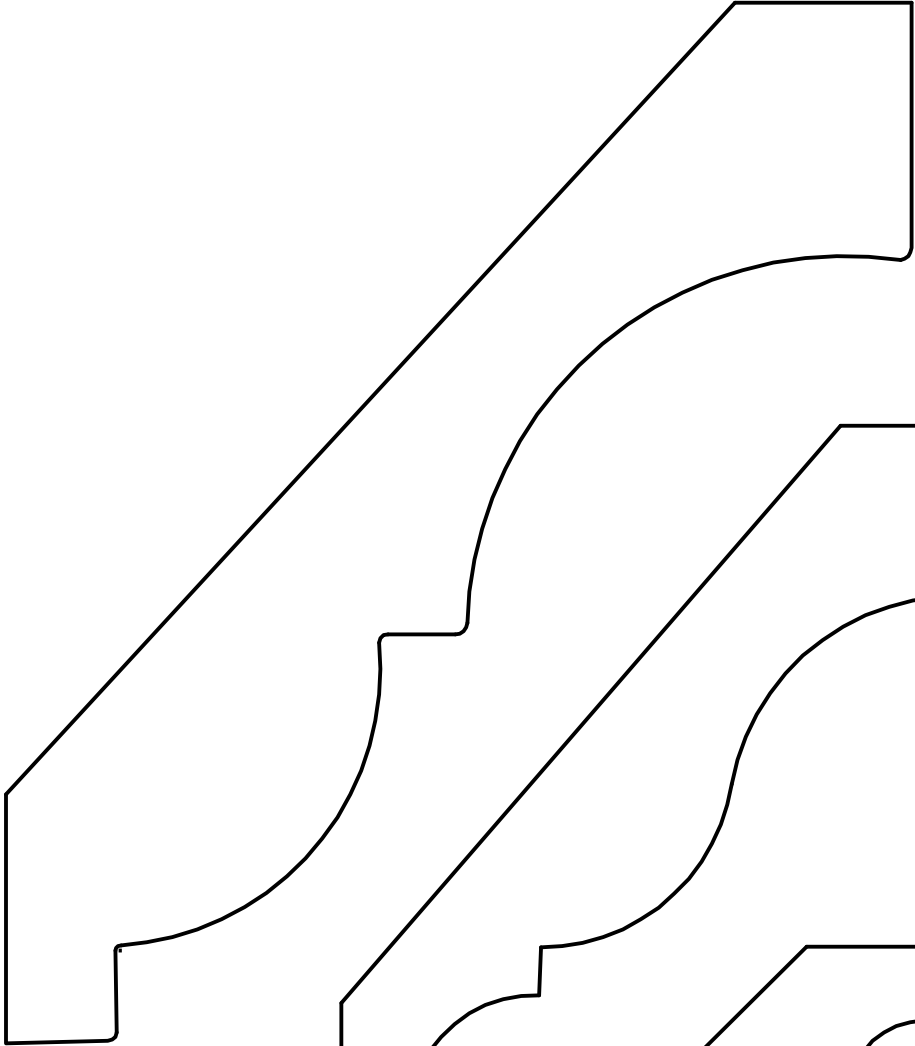

MI # 277
1 5/8" x 7 1/4"
K-423

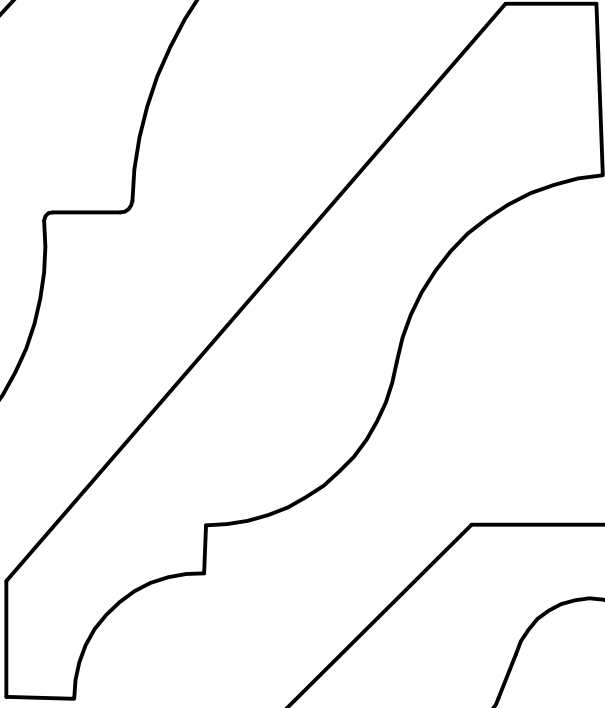

MI # 278
1" x 4 3/4"
K-421

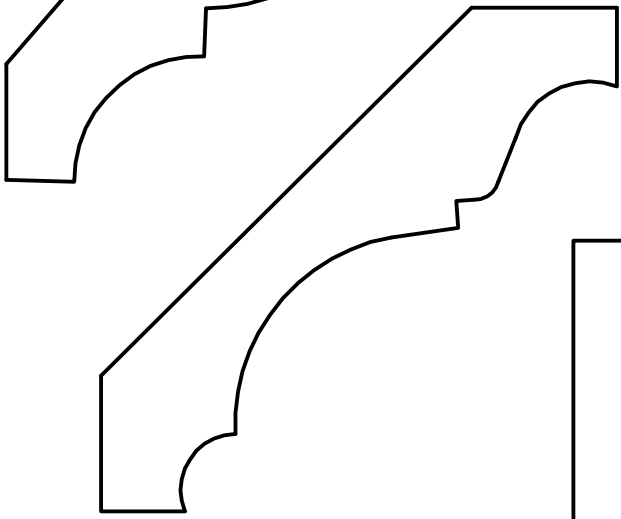

MI # 279
3/4" x 3 3/4"
K-487

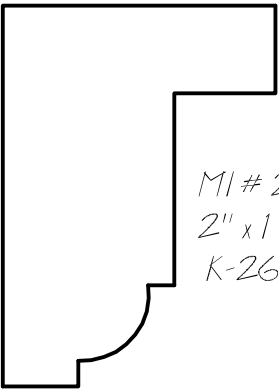

MI # 280
2" x 1 1/2"
K-267



MI # 281
1 11/16" x 1 1/16"
K-322

MILLWORK INTERNATIONAL INC. CROWNS
MI 200 SECTION

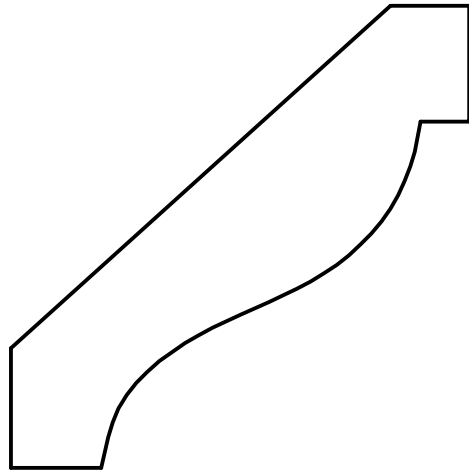

MI # 282
7/8" x 3 3/8"
K-288

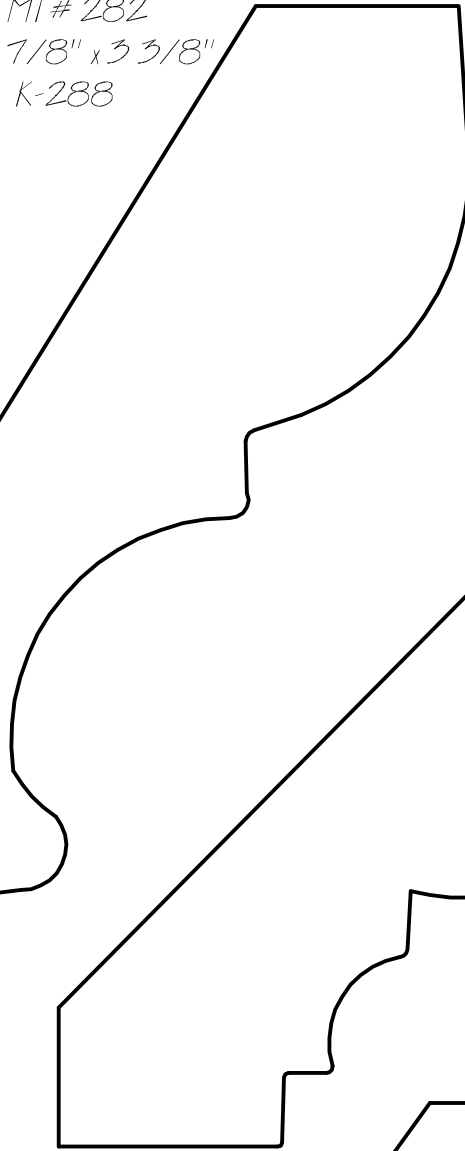

MI # 283
1 3/4" x 6 7/8"
K-419

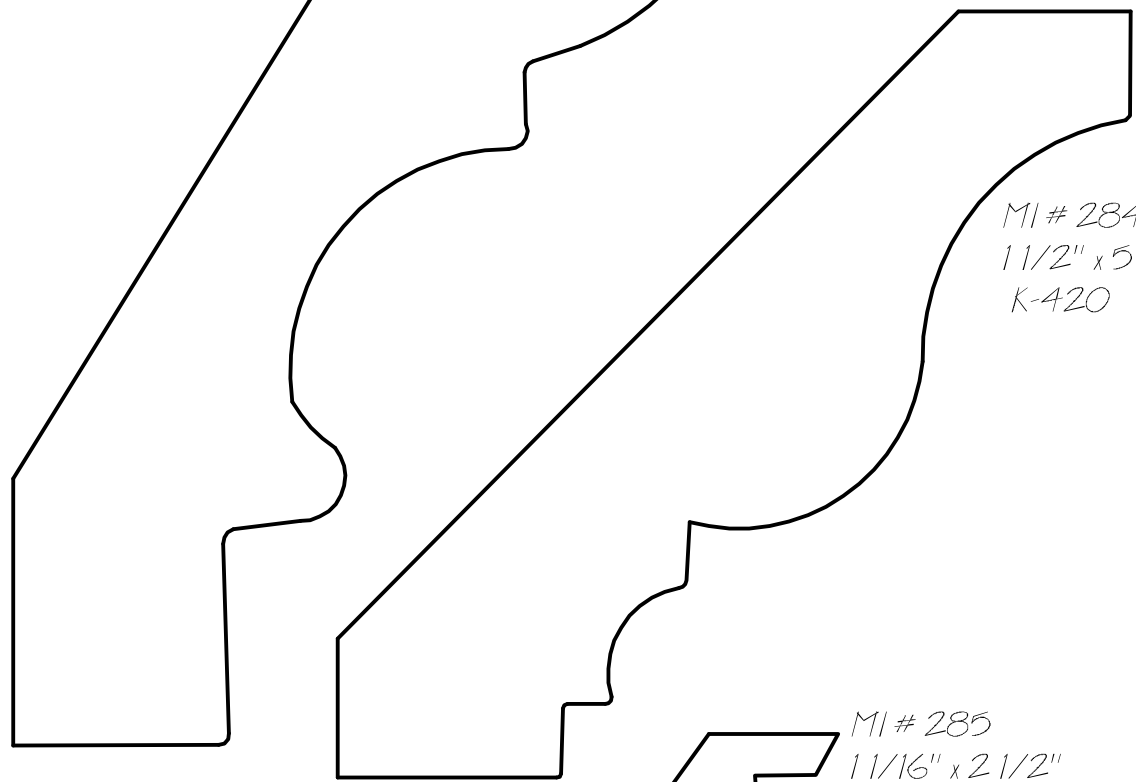

MI # 284
1 1/2" x 5 3/4"
K-420

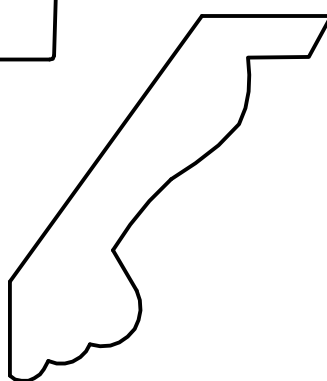

MI # 285
1 1/16" x 2 1/2"
K-511

MILLWORK INTERNATIONAL INC, CROWNS

MI 200 SECTION

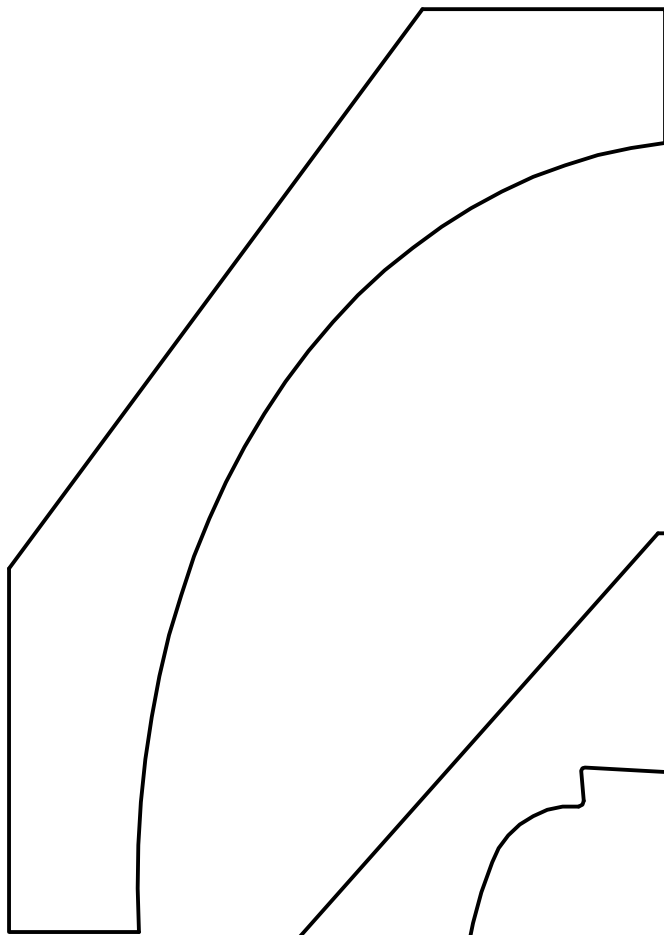

MI # 286
1 3/4" x 5 7/8"
K-260

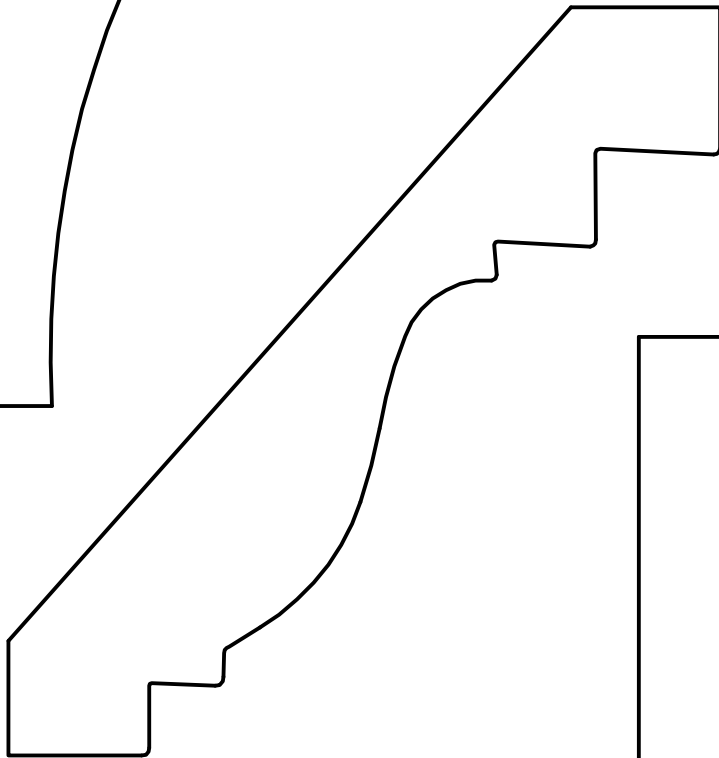

MI # 287
1 1/8" x 5 3/8"
K-407

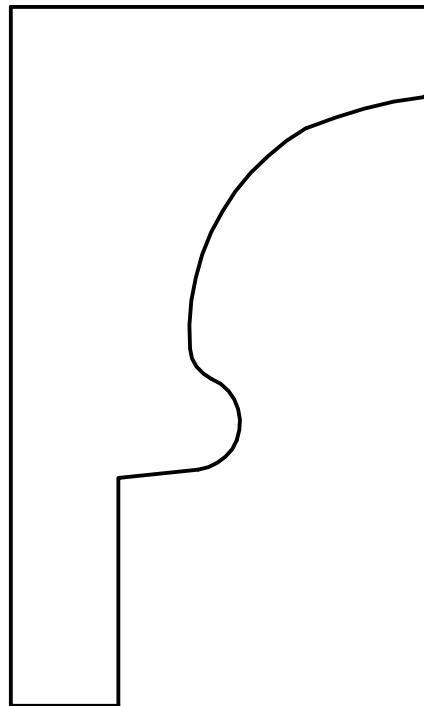

MI # 288
2 3/16" x 3 5/8"
K-418

MILLWORK INTERNATIONAL INC. CROWNS

MI 200 SECTION

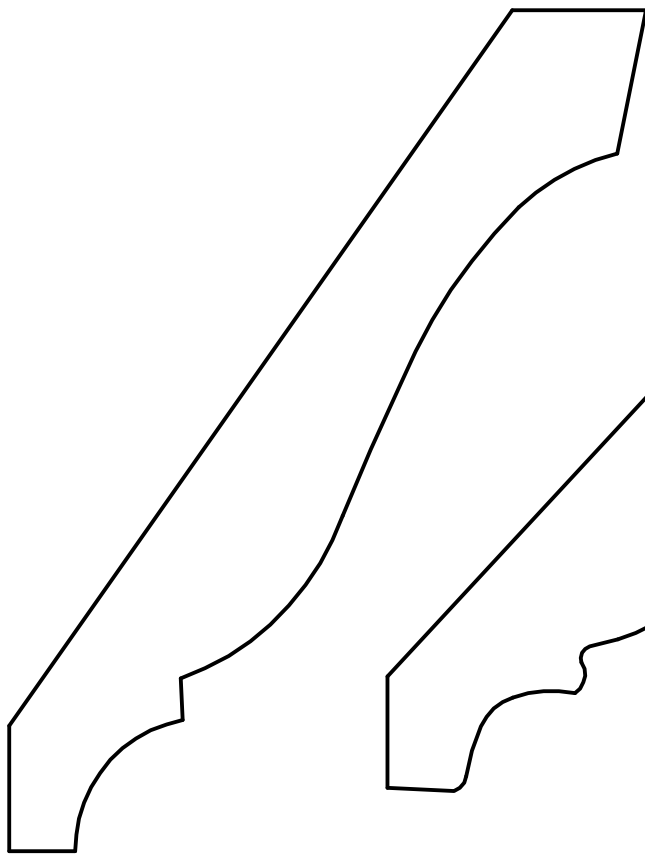

MI # 289
1" x 5 1/2"
K-422

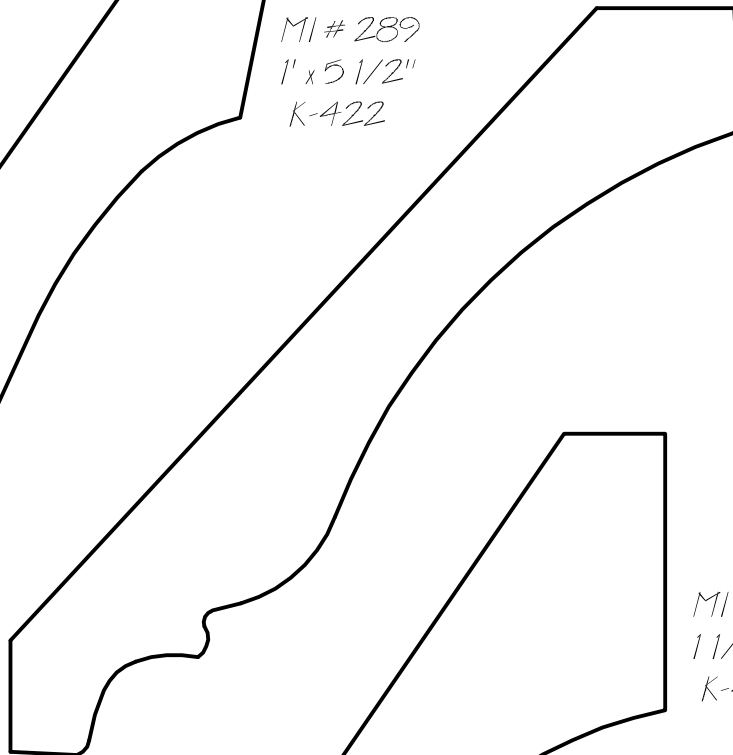

MI # 290
1" x 5 1/2"
K-481

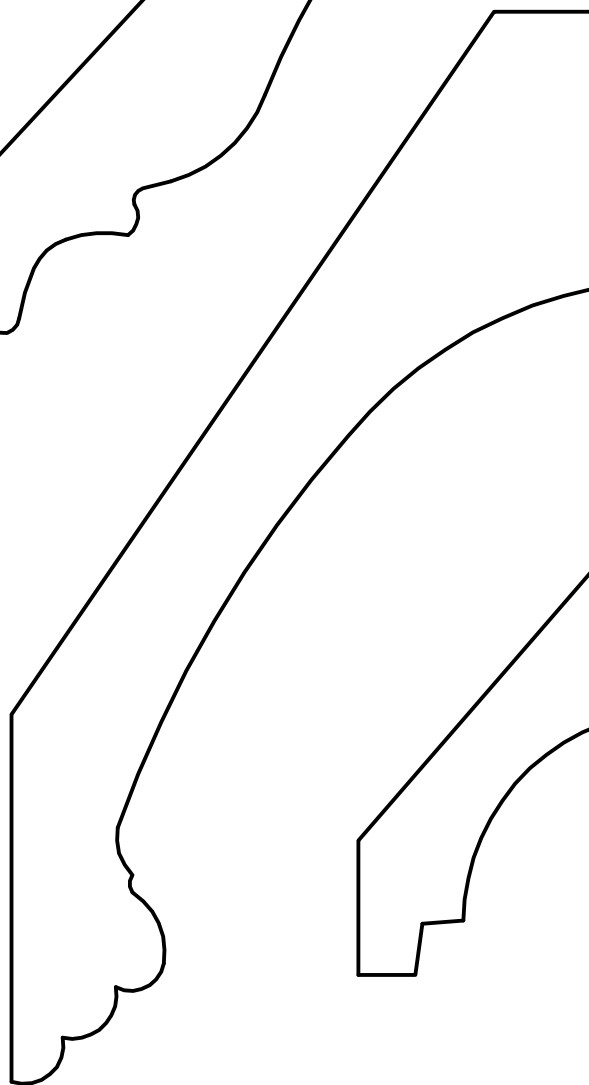

MI # 291
1 1/2" x 6 3/8"
K-491

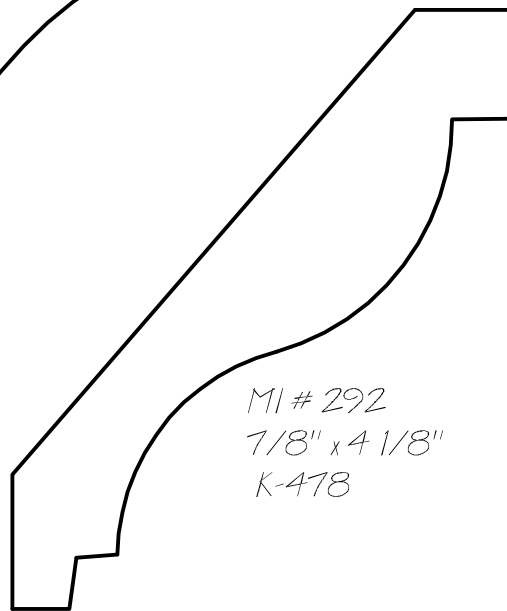

MI # 292
7/8" x 4 1/8"
K-478

MILLWORK INTERNATIONAL INC. CROWNS

MI 200 SECTION

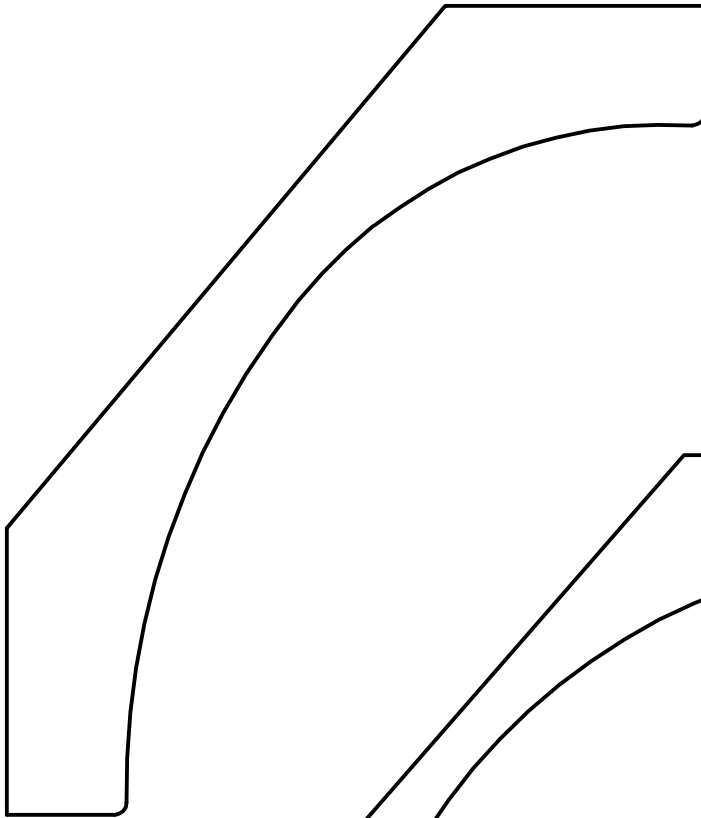

MI # 293
6 3/4" X 1 7/16"
K-538

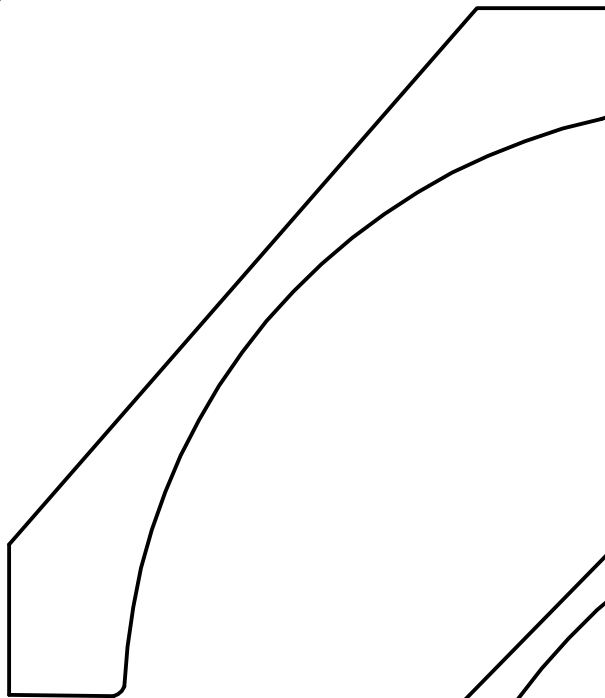

MI # 294
1" x 4 3/4"
K-424

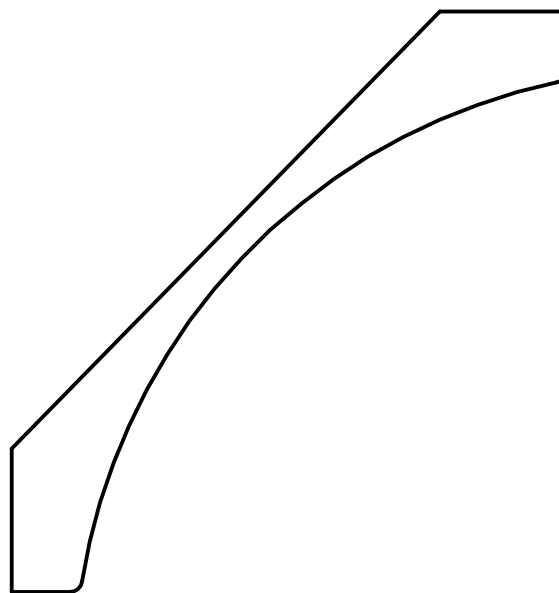

MI # 295
3/4" x 4 1/4"
K-425